

PLEASE FIND A QUALIFIED ELECTRICIAN FOR INSTALLATION.

Please read the instruction before you install and use the luminaire.

SPECIFICATIONS

ITEM#	DESCRIPTION	WATT	COLOR	LUMENS	CRI	VOLT	HOURS	CASE
55165	LED VAPOR TIGHT 48" 40W/50K/FROSTED LENS/120-277V/DIMMABLE - SUPERIOR LIFE®	40	5000K	3636	85	120-277	50,000	6

This fixture is suitable for wet locations, IP65. *Published lumens on LED products are approximate and may vary slightly.*

SAFETY INSTRUCTIONS

READ AND FOLLOW ALL SAFETY INSTRUCTIONS

- Disconnect the power supply while replacing or maintaining the product to prevent electrical shock
- Reconstruction or the use of accessory equipment is not recommended. May cause unsafe conditions and will void the warranty.
- Servicing of this equipment should be performed by a qualified electrician.
- Do not mount near electric or gas heaters.
- Do not use this equipment for other than its intended purpose
- SAVE THESE INSTRUCTIONS

INSTALLATION

WARNINGS

**DISCONNECT POWER BEFORE
INSTALLING OR SERVICING**

1. PRODUCT INSTALLATION

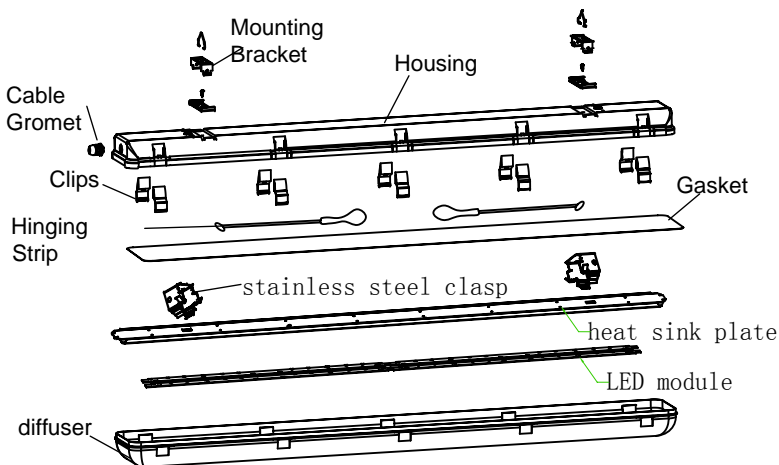

2. MOUNTING BRACKETS (Take-down and install)

1. Use screwdriver to pry open the clips, without removing them from housing.

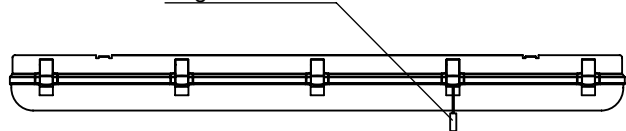

2. Take down diffuser clips

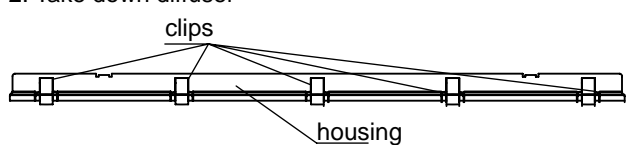

3. Install or replace lamps

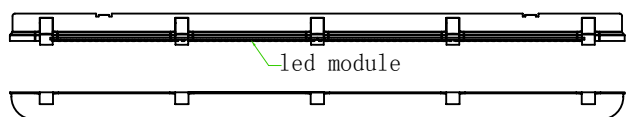

4. Replace diffuser and push clips inward

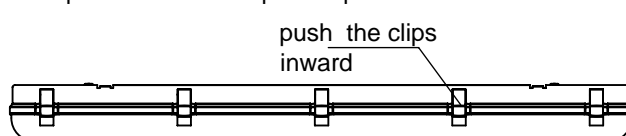



PREMIUM QUALITY LIGHTING

55165 LED 40W VAPOR TIGHT INSTALL INSTRUCTIONS



INSTALLATION

3. Power connection

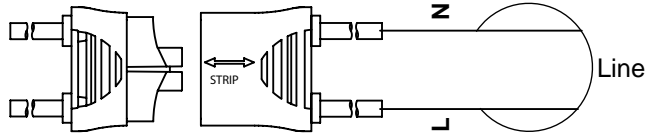

4. Clip Installation

Clips' matching part of the housing
Make sure the shape of the clip and housing match and push into place.

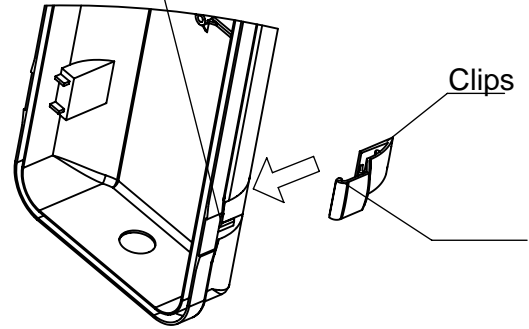

MOUNTING

3. Chain Mounting

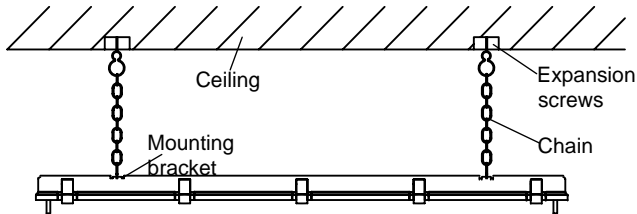

4. Ceiling Mounting

