

**READ AND FOLLOW ALL SAFETY INSTRUCTIONS!
SAVE THESE INSTRUCTIONS AND DELIVER TO OWNER AFTER INSTALLATION**

- To reduce the risk of death, personal injury or property damage from fire, electric shock, falling parts, cuts/abrasions, and other hazards please read all warnings and instructions included with and on the fixture box and all fixture labels.
- Before installing, servicing, or performing routine maintenance upon this equipment, follow these general precautions.
- Installation and service of luminaires should be performed by a qualified licensed electrician.
- Maintenance of the luminaires should be performed by person(s) familiar with the luminaires' construction and operation and any hazards involved. Regular fixture maintenance programs are recommended.
- It will occasionally be necessary to clean the outside of the refractor/lens. Frequency of cleaning will depend on ambient dirt level and minimum light output which is acceptable to user. Refractor/lens should be washed in a solution of warm water and any mild, non-abrasive household detergent, rinsed with clean water and wiped dry. Should optical assembly become dirty on the inside, wipe refractor/lens and clean in above manner, replacing damaged gaskets as necessary.
- **DO NOT INSTALL DAMAGED PRODUCT!** This luminaire has been properly packed so that no parts should have been damaged during transit. Inspect to confirm. Any part damaged or broken during or after assembly should be replaced.
- **Recycle:** For information on how to recycle LED electronic products, please visit www.epa.gov.
- These instructions do not purport to cover all details or variations in equipment nor to provide every possible contingency to meet in connection with installation, operation, or maintenance. Should further information be desired or should particular problems arise which are not covered sufficiently for the purchaser's or owner's purposes, this matter should be referred to Acuity Brands Lighting, Inc.

<div style="display: flex; align-items: center; margin-bottom: 10px;"> <div style="border: 1px solid black; padding: 5px; text-align: center; flex-grow: 1;"> <p>WARNING RISK OF ELECTRIC SHOCK</p> </div> </div> <ul style="list-style-type: none"> ✓ Disconnect or turn off power before installation or servicing. ✓ Verify that supply voltage is correct by comparing it with the luminaire label information. ✓ Make all electrical and grounded connections in accordance with the National Electrical Code (NEC) and any applicable local code requirements. ✓ All wiring connections should be capped with UL approved recognized wire connectors. 	<div style="display: flex; align-items: center; margin-bottom: 10px;"> <div style="border: 1px solid black; padding: 5px; text-align: center; flex-grow: 1;"> <p>WARNING RISK OF BURN</p> </div> </div> <ul style="list-style-type: none"> ✓ Allow lamp/fixture to cool before handling. Do not touch enclosure or light source. ✓ Do not exceed maximum wattage marked on luminaire label. ✓ Follow all manufacturer's warnings, recommendations and restrictions for: driver type, burning position, mounting locations/methods, replacement and recycling.
--	---

<div style="display: flex; align-items: center; margin-bottom: 10px;"> <div style="border: 1px solid black; padding: 5px; text-align: center; flex-grow: 1;"> <p>CAUTION RISK OF INJURY</p> </div> </div> <ul style="list-style-type: none"> ✓ Wear gloves and safety glasses at all times when removing luminaire from carton, installing, servicing or performing maintenance. ✓ Avoid direct eye exposure to the light source while it is on. 	<div style="display: flex; align-items: center; margin-bottom: 10px;"> <div style="border: 1px solid black; padding: 5px; text-align: center; flex-grow: 1;"> <p>CAUTION RISK OF FIRE</p> </div> </div> <ul style="list-style-type: none"> ✓ Keep combustible and other materials that can burn, away from lamp/lens. ✓ Do not operate in close proximity to persons, combustible materials or substances affected by heat or drying.
---	--

LED IMPORTANT SAFETY INSTRUCTIONS



CAUTION: RISK OF PRODUCT DAMAGE

- ✓ Never connect components under load.
- ✓ Do not mount or support these fixtures in a manner that can cut the outer jacket or damage wire insulation.
- ✓ Unless individual product specifications deem otherwise: Never connect an LED product directly to a dimmer packs, occupancy sensors, timing devices, or other related control devices. LED fixtures must be powered directly off a switched circuit.
- ✓ Unless individual product specifications deem otherwise: Do not restrict fixture ventilation. Allow for some volume of airspace around fixture. Avoid covering LED fixtures with insulation, foam, or other material that will prevent convection or conduction cooling.
- ✓ Unless individual product specifications deem otherwise: Do not exceed fixtures maximum ambient temperature.
- ✓ Only use fixture in its intended location.
- ✓ LED products are Polarity Sensitive. Ensure proper Polarity before installation.
- ✓ Electrostatic Discharge (ESD): ESD can damage LED fixtures. Personal grounding equipment must be worn during all installation or servicing of the unit.
- ✓ Do not touch individual electrical components as this can cause ESD, shorten lamp life, or alter performance.
- ✓ Some components inside the fixture may not be serviceable. In the unlikely event your unit may require service, stop using the unit immediately and contact an ABL representative for assistance.
- ✓ Always read the fixtures complete installation instructions prior to installation for any additional fixture specific warnings.

Please see product specific installation instructions for additional warnings or any applicable FCC or other regulatory statements.

Failure to follow any of these instructions could void product warranties. For a complete listing of product Terms and Conditions, please visit www.acuitybrands.com.

Our Brands	Indoor/Outdoor Lithonia Lighting Carandini Holophane RELOC Light Concepts	Indoor Lighting Gotham Mark Architectural Lighting Peerless Renaissance Lighting Winona Lighting	Outdoor Lighting American Electric Lighting Antique Street Lamps Hydrel Tersen	Controls DARK TO LIGHT LC&D ROAM Sensor Switch Synergy	Daylighting SunOptics
-------------------	---	--	---	--	---------------------------------

Acuity Brands Lighting, Inc. assumes no responsibility for claims arising out of improper or careless installation or handling of its products.

ABL LED General Warnings, Form No. 503.203

© 2010 Acuity Brands Lighting, Inc. All rights reserved. 12/01/10

Installation Instructions

D-Series Size 1 LED Wall

5 year limited warranty

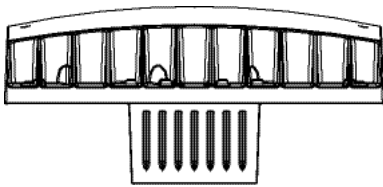

DELIVERY: Upon receipt of fixture and accessories (packed separately), thoroughly inspect for any freight damage. All damage should be reported to the delivery carrier. Compare the catalog description listed on the packing slip with the fixture label on the inside of the housing to be sure you have received the correct merchandise.

This device complies with Part 15 of the FCC Rules. Operation is subject to the following two conditions: (1) this device may not cause harmful interference, and (2) this device must accept any interference received, including interference that may cause undesired operation.

⚠ CAUTION: APPLY A CONTINUOUS BEAD OF WEATHER - PROOF CAULKING BETWEEN MOUNTING PLATE AND WALL TO ENSURE WEATHER - TIGHT INTEGRITY OF ELECTRICAL COMPONENTS.

Tools Required: #2 philips type screwdriver, 1/4" hex driver. ELCW option also requires 11/32" closed end wrench.

Preparing the J-box for D-Series Size 1 LED Wall fixture mounting:

Remove one of the j-box screws. Loosen the remaining j-box screw. Remove the J-box adaptor strap from the supplied hardware bag and position the strap keyhole over the loosened j-box screw. Align the remaining strap slot over the j-box screw mounting hole. Insert the j-box screw and tighten. Tighten the remaining j-box screw. Remove the two screws from the supplied hardware bag and select holes on the j-box strap that are as horizontally opposed as possible. Next you will need a 1/4 hex driver. Do not tighten the screws all the way because you will be mounting the back of the light fixture onto these screws.

Mounting the D-Series Size 1 LED Wall standard fixture to a J-box:

Loosen the light fixtures cover screws and unsnap the electrical connectors that connect the cover to the main fixture housing. Now place the cover assembly aside until the last steps. Pull wires from the j-box in through the oblong wire access opening on the back of the main fixture housing. Position the back of the fixture housing such that the two adaptor strap screw heads will fit through the keyhole slots in the fixture housing. Now rotate the entire housing assembly until fixture is level. With a standard or small size ratchet and a 1/4" hex driver, tighten the two adaptor strap screws.

Take the cover assembly and snap the electrical connectors together with the main light fixture connectors. Place cover assembly back onto the main light fixture housing taking care not to pinch any wires. Tighten the two cover closing screws with a Phillips style screwdriver.

Mounting the D-Series Size 1 LED Wall ELCW fixture to a J-box:

Loosen the light fixtures cover screws and unsnap the electrical connectors that connect the cover to the main fixture housing. Now place the cover assembly aside until the last steps.

Take the main fixture housing and unsnap the two single electrical connectors that connect to the small fuseholder. Using an 11/32" closed end wrench remove and save the two nuts that connect the main fixture housing to the emergency backbox. Remove the main fixture housing and pull the two single electrical connectors through the oblong wire access opening on the back of the main fixture housing. Pull the remaining wires out of the emergency backbox through the emergency backbox cover wire access and unsnap the electrical connectors. Now the main fixture housing can be set aside.

Take a Phillips style screwdriver and loosen the four screws on the back box cover assembly until the cover assembly can be removed from the backbox. Unsnap the remaining electrical connections so that the cover assembly can be placed aside. Pull wires from the j-box in through the oblong wire access opening on the back of the backbox. Position the back of the backbox such that the two adaptor strap screw heads will fit through the keyhole slots in the fixture housing. Now rotate the backbox until it is level. With a 1/4" hex driver, tighten the two adaptor strap screws.

Take the backbox cover assembly and reconnect electrical connectors. The connectors that connect the backbox to the main fixture housing and the small fuseholder wires will need to be on the outside of the backbox cover wire access hole. Place the backbox cover assembly onto the backbox and tighten the four screws. Take the two single electrical connectors that connect to the small fuseholder and feed them back into the main housing. Take the remaining connectors coming from the back of the main housing and reconnect to the backbox connectors. Place these connectors back through the backbox cover wire access opening. Now take the two nuts and tighten the main housing to the backbox cover. Reconnect the remaining connectors from the light fixture cover to the main housing.

Read the provided emergency instruction sheet (included in carton as a separate document) fully before making the last connection which will be the connection of the small fuseholder/convertor.

Place light fixture cover assembly back onto main light fixture housing taking care not to pinch any wires. Tighten the two cover closing screws with a Phillips style driver.

Installing D-Series Size 1 LED Wall Bird Spikes (if the full length of the spike assembly is not desired, sections can be removed prior to assembly by snapping sections off.)

1. Remove the screws (2 for the DSXW1 & 4 for the DSXW2) that holds the light fixture electrical cover in place. Then remove the cover assembly by disconnecting the quick disconnects. The spike assembly will be installed using the provided self drilling screws.
2. Remove the paper backing from one side of the provided gasket and apply the gasket to the spike assembly.
3. Remove the paper backing from the remaining side of the gasket.
4. Select the spike assembly location so that the self drilling screws do not damage the fixture electricals.
5. Press the spike assembly onto your selected location and attach with the self drilling screws.
6. Snap the quick disconnects back together. Reinstall the cover taking care not to pinch any wires.

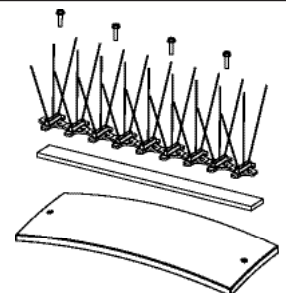

Installation Instructions

D-Series Size 1 LED Wall

Mounting the D-Series Size 1 LED Wall standard fixture to a back box (BBW):

Back box will be provided with (3) 3/4" NPT hole plugs, one on top and on each side. (See Figure A).

See the back box in Figure B for the location of the cast-in drill point indentations provided for Step 1 below.

Figure A

Side view

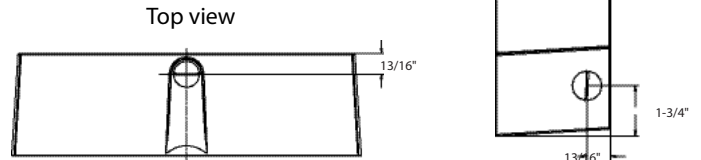

Step 1: Drill the back box as shown in Figure B to prepare it for 1/4" anchor bolts (not provided) in 2 places with 9/32" drill.

Step 2: Place drilled back box against the wall, mark wall and drill for the anchors (not provided).

Step 3: Install (2) anchors (not provided) securely into wall and attach the back box. Install surface-mount conduit and secure with 3/4" NPT locking nut (not provided). Do not over tighten.

Step 4: Secure green grounding wire from supply conductors to grounding lug in back box.

Step 5: Apply bead of silicone sealant (not provided) around perimeter of back box.

Step 6: Consult fixture installation instruction to complete installation.

Figure B

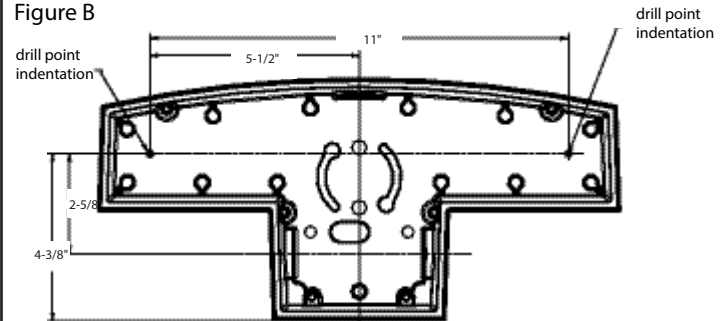

Installing the D-Series Size 1 LED Wall Wire Guard

Step 1: Take one of the wire guard brackets and place it against the edge of the cast housing. Locate the bracket hole 2-11/16" away from the front of the housing as shown in Figure A. Use bracket as a drill guide. Use a #26 drill bit (.146 to .150 dia) and drill through in 2 places taking care not to drill into the LED lights. Repeat these steps on the other side.

Step 2: Using a 1/4" hex drive, attach the wire guard brackets to the cast housing as shown in Figure B. The screws will create their own threads in the holes you drilled in Step 1. Now take the remaining screws and attach the shield to the wire guard brackets.

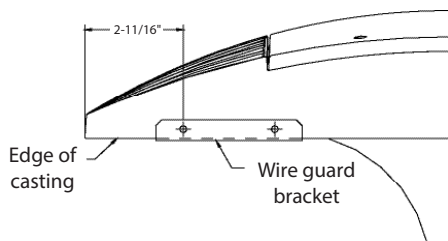

Figure A

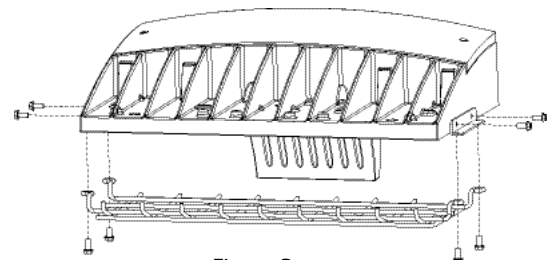

Figure B

Installing the D-Series Size 1 LED Wall Vandal Guard

Step 1: Take one of the vandal guard brackets and place it against the edge of the cast housing. Locate the bracket hole 1-3/4" away from the front of the housing as shown in Figure A. Use bracket as a drill guide. Use a #26 drill bit (.146 to .150 dia) and drill through in 2 places taking care not to drill into the LED lights. Repeat these steps on the other side.

Step 2: Using a 1/4" hex drive, attach the vandal guard brackets to the cast housing as shown in Figure B. The screws will create their own threads in the holes you drilled in Step 1.

Step 3: Take the vandal guard plastic shield and remove any protective film that it may have been shipped with. Now take the remaining screws and attach the shield to the vandal guard brackets.

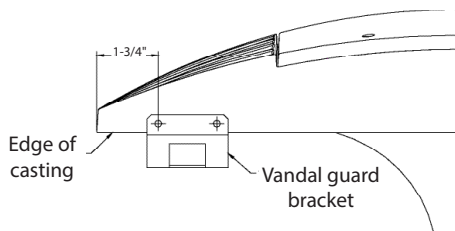

Figure A

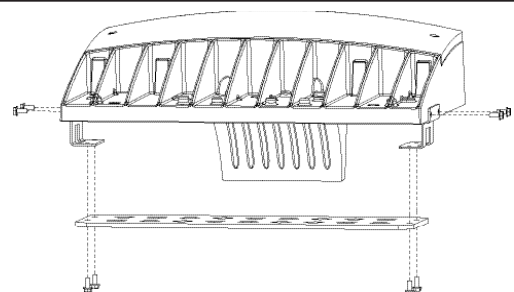

Figure B

Troubleshooting: If this fixture fails to operate properly, check to make sure: • The fixture is wired correctly. • The fixture is grounded correctly. • The line voltage at the fixture is correct. If all these variables have been checked and the fixture still does not operate as specified, contact your local Lithonia Lighting distributor.