



# PAR38

## Dimmable Recessed Light

120W halogen equivalent

### Features

- Innovative anti-glare lens technology
- ENERGY STAR certified (3000K)
- Available in a variety of CCTs and beam angles
- Special high CRI models
- Top performing light output and efficacy
- High Power Factor
- Compatible with most ANSI/NEMA approved dimmers designed for LED use
- UL certified
- Comprehensive five-year warranty
- Tested per IESNA LM-79-2008



Leapfrog Lighting's ENERGY STAR certified PAR38 LED lamp provides industry-leading light quality, output power, and efficacy as a result of our patented intelligent optics lens and high-efficiency, high-reliability LED source and driver electronics.

#### LIGHT QUALITY

Evenly distributed, glare-free light with gentle roll-off at edges

#### APPLICATIONS

Indoor and unexposed outdoor down-lighting applications

#### LIFE EXPECTANCY

40,000 hours  
ENERGY STAR rated models: 25,000 hours based on preliminary testing

#### PERFORMANCE

Dimmable, high efficacy (lm/W), single light source

#### COLOR

Ultra-consistent color temperature control critical to multi-lamp applications, with high CRI and pleasing CCT options.

#### WATTAGE EQUIVALENCY

120 Watt halogen equivalent

### SPECIFICATIONS

CCT <sup>1</sup>	CRI <sup>2</sup>	BEAM	LM	W	LM/W	PART
2700K	82	20°	1285	17	76	1002-P38LC-2703
	82	38°	1285	17	76	1002-P38LC-2701
	82	60°	1285	17	76	1002-P38LC-2702
	95	20°	1067	17	63	1002-P38LC-2706
	95	38°	1067	17	63	1002-P38LC-2704
3000K	95	60°	1067	17	63	1002-P38LC-2705
	81	20°	1310	17	77	1002-P38LC-3003
	81	38°	1310	17	77	1002-P38LC-3001
	81	60°	1310	17	77	1002-P38LC-3002
	95	20°	1087	17	64	1002-P38LC-3006
5000K	95	38°	1087	17	64	1002-P38LC-3004
	95	60°	1087	17	64	1002-P38LC-3005
	82	20°	1365	17	80	1002-P38LC-5003
	82	38°	1365	17	80	1002-P38LC-5001
	82	60°	1365	17	80	1002-P38LC-5002
95	20°	1133	17	67	1002-P38LC-5006	
	38°	1133	17	67	1002-P38LC-5004	
	60°	1133	17	67	1002-P38LC-5005	

1. Tolerances as per ANSI C78.377-2008 Nominal CCT categories  
2. CRI refers to the "General CRI" described as Ra in CIE 13.3

#### GENERAL

Min. lifetime <sup>3</sup>	40,000 hours
Base type	E26/E27
Weight	14.6 oz.
Dimensions <sup>4</sup>	PAR38L

#### ELECTRICAL

Voltage, nominal	120 VAC
Power factor	> 0.95
Dimming range	Flicker free down to 10% light output

#### OPTICAL

Duv <sup>5</sup>	< 0.006
------------------	---------

3. Lifetime as defined by IESNA LM-80  
4. Compatible with ANSI C78.21-2011 dimensional requirements  
5. Duv values and tolerances as per ANSI C78.377-2008 Nominal CCT, Table 1, page 8

#### BASE TYPE



PAR38 DIMMER COMPATIBILITY (North America)

MANUFACTURER	BRAND	MODEL	NUMBER OF LAMPS / DIMMER										
			1	2	3	4	5	6	7	8	9	10	
Lutron	Skylark	s-600P-WH	OK	OK	OK	OK	OK	OK	OK	OK	OK	OK	OK
	Maestro	MS-OP600GHW-WH	-	OK	-	OK	OK	-	-	-	-	-	-
	Toggler	TGCL-153PH-WH	OK	OK	OK	OK	OK	OK	OK	OK	OK	OK	OK
Leviton	Decora	IPI106	-	OK	OK	OK	OK	OK	OK	OK	OK	OK	OK
	SURESLIDE	6633-P	OK	OK	OK	OK	OK	OK	OK	OK	OK	OK	OK
Panasonic	Panasonic	WN576280K	OK	OK	OK	OK	OK	OK	OK	OK	OK	OK	OK
Incandescent	Slide dimmer	DMS-SIL	OK	OK	OK	OK	OK	OK	OK	OK	OK	OK	OK

POLAR INTENSITY DIAGRAMS

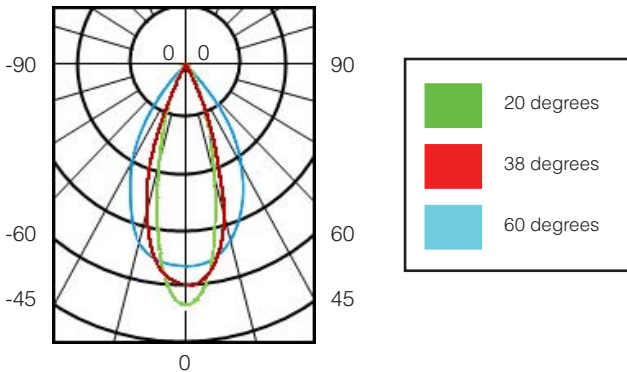

DIMENSIONS

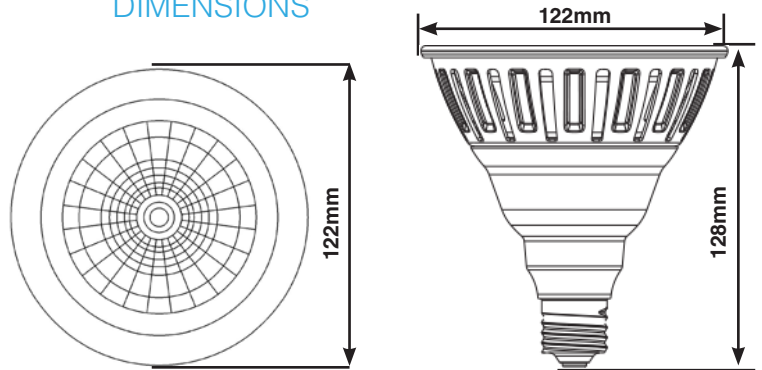

SPECTRAL POWER DISTRIBUTION

2700K

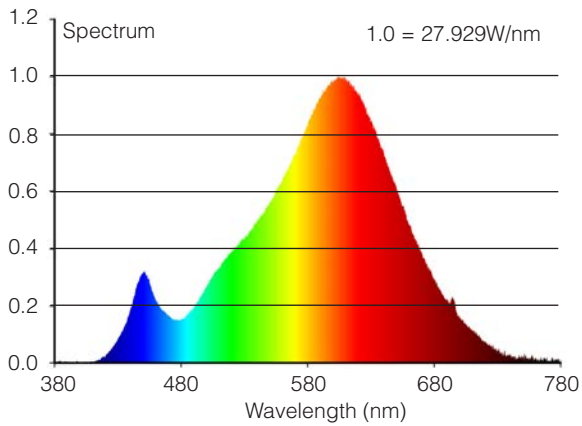

3000K

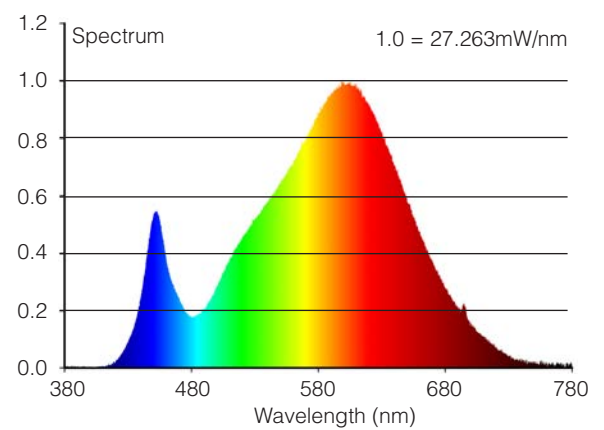

5000K

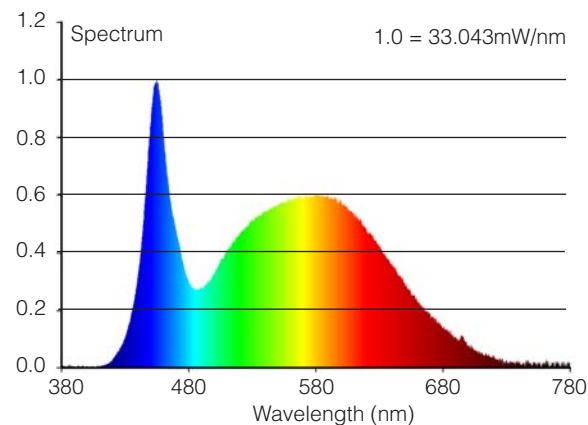

## BEAM ANGLES

### 20 degrees

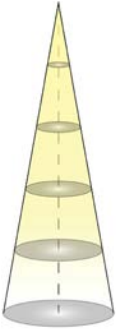

DISTANCE (m)	AVG./MAX. E (lux)			DIAMETER (m)
	2700K	3000K	5000K	
1	4885 / 6781	5234 / 7265	5627 / 7810	0.33
2	1221 / 1695	1308 / 1816	1406 / 1952	0.66
3	542 / 753	581 / 807	625 / 867	0.99
4	305 / 423	327 / 454	351 / 488	1.32
5	195 / 271	210 / 290	225 / 312	1.66

### 38 degrees

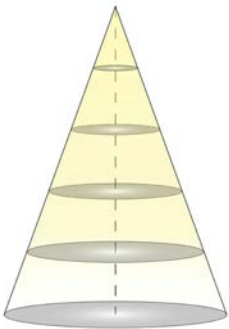

DISTANCE (m)	AVG./MAX. E (lux)			DIAMETER (m)
	2700K	3000K	5000K	
1	2247 / 3147	2407 / 3371	2588 / 3624	0.60
2	561 / 786	602 / 843	647 / 906	1.21
3	249 / 349	267 / 374	287 / 402	1.81
4	140 / 197	150 / 210	161 / 226	2.42
5	90 / 126	96 / 134	103 / 145	3.02

### 60 degrees

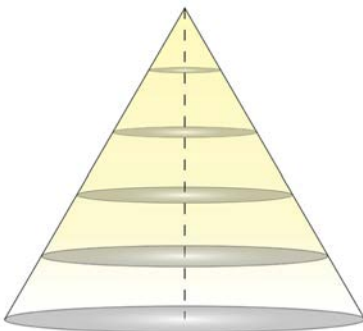

DISTANCE (m)	AVG./MAX. E (lux)			DIAMETER (m)
	2700K	3000K	5000K	
1	938 / 1582	1005 / 1695	1080 / 1822	0.60
2	234 / 395	251 / 423	270 / 455	1.21
3	104 / 175	111 / 188	120 / 202	1.81
4	59 / 99	62 / 106	67 / 114	2.42
5	37 / 63	40 / 67	43 / 73	3.02

#### WARRANTY

If the lamp fails to meet our specifications during the first 60 months, we'll replace it.

For additional warranty information, please refer to <http://www.leapfroglighting.com/resources/>.

#### APPLICATION NOTES

Not for use in exposed outdoor down-lighting applications

Ambient temperature within -20 to +45 °C

#### SAFETY NOTES

Warning: Risk of electric shock

Do not disassemble (no user serviceable parts)

Turn off power before inspection, installation or removal.