

READ AND FOLLOW ALL SAFETY INSTRUCTIONS! SAVE THESE INSTRUCTIONS AND DELIVER TO OWNER AFTER INSTALLATION

- To reduce the risk of death, personal injury or property damage from fire, electric shock, falling parts, cuts/abrasions, and other hazards please read all warnings and instructions included with and on the fixture box and all fixture labels.
- Before installing, servicing, or performing routine maintenance upon this equipment, follow these general precautions.
- Installation and service of luminaires should be performed by a **qualified licensed electrician**.
- Maintenance of the luminaires should be performed by person(s) familiar with the luminaires' construction and operation and any hazards involved. Regular fixture maintenance programs are recommended.
- It will occasionally be necessary to clean the outside of the refractor/lens. Frequency of cleaning will depend on ambient dirt level and minimum light output which is acceptable to user. Refractor/lens should be washed in a solution of warm water and any mild, non-abrasive household detergent, rinsed with clean water and wiped dry. Should optical assembly become dirty on the inside, wipe refractor/lens and clean in above manner, replacing damaged gaskets as necessary.
- **DO NOT INSTALL DAMAGED PRODUCT!** This luminaire has been properly packed so that no parts should have been damaged during transit. Inspect to confirm. Any part damaged or broken during or after assembly should be replaced.
- Recycle: For information on how to recycle LED electronic products, please visit www.epa.gov.
- These instructions do not purport to cover all details or variations in equipment nor to provide every possible contingency to meet in connection with installation, operation, or maintenance. Should further information be desired or should particular problems arise which are not covered sufficiently for the purchaser's or owner's purposes, this matter should be referred to Acuity Brands Lighting, Inc.



WARNING RISK OF ELECTRIC SHOCK

- Disconnect or turn off power before installation or servicing.
- Verify that supply voltage is correct by comparing it with the luminaire label information.
- Make all electrical and grounded connections in accordance with the National Electrical Code (NEC) and any applicable local code requirements.
- All wiring connections should be capped with UL approved recognized wire connectors.



CAUTION RISK OF INJURY

- Wear gloves and safety glasses at all times when removing luminaire from carton, installing, servicing or performing maintenance.
- Avoid direct eye exposure to the light source while it is on.



WARNING RISK OF BURN

- Allow lamp/fixture to cool before handling. Do not touch enclosure or light source.
- Do not exceed maximum wattage marked on luminaire label.
- Follow all manufacturer's warnings, recommendations and restrictions for: driver type, burning position, mounting locations/methods, replacement and recycling.



CAUTION RISK OF FIRE

- Keep combustible and other materials that can burn, away from lamp/lens.
- Do not operate in close proximity to persons, combustible materials or substances affected by heat or drying.



CAUTION: RISK OF PRODUCT DAMAGE

- Never connect components under load.
- Do not mount or support these fixtures in a manner that can cut the outer jacket or damage wire insulation.
- Never connect an LED product to an unapproved dimmer pack. Contact ABL directly for any dimmers not specifically recommended for the product.
- Unless individual product specifications deem otherwise: Allow for some volume of airspace around fixture. Avoid covering LED fixtures with insulation, foam, or other material that will prevent convection or conduction cooling.
- Unless individual product specifications deem otherwise: Maximum ambient temperature is 90°C. Do not operate fixture at temperatures higher than this.
- Unless individual product specifications deem otherwise: Never mount in places where fixture will be exposed to rain, high humidity, extreme temperature changes or restricted ventilation.
- LED products are Polarity Sensitive. Ensure proper Polarity before installation.
- Electrostatic Discharge (ESD): ESD can damage LED fixtures. Personal grounding equipment must be worn during all installation or servicing of the unit.
- Do not touch individual electrical components as this can cause ESD, shorten lamp life, or alter performance.
- There are no user serviceable parts inside the unit. Do not rewire, reconfigure, or modify the unit or attempt any repairs yourself. Additionally, field replacement of the LED assembly or lamps is not allowed by UL standards at this time. In the unlikely event your unit may require service, stop using the unit immediately and contact an ABL representative.

All luminaires that contain electronic devices that generate frequencies above 9kHz from any component within the luminaire comply with one of the following Part 15 of the FCC Rules. Operation is subject to the following two conditions:

- (1) This device may not cause harmful interference
- (2) This device must accept any interference received, including interference that may cause undesired operation.

This device complies with Part 18 of the FCC Rules but may cause interference with cordless and cell phones, radios, televisions, and other electronic devices. To correct the problem move the device away from the luminaire or plug into a different outlet. This product may cause interference to radio equipment and should not be installed near maritime safety communications equipment or other critical navigation or communications equipment operating between 0.45-30MHz.

Failure to follow any of these instructions could void product warranties. For a complete listing of product Terms and Conditions, please visit www.acuitybrands.com.

OUR BRANDS

Indoor/Outdoor: Lithonia Lighting, Carandini, Holophane, RELOC

Indoor Lighting: Gotham, Mark Architectural Lighting, Peerless, Renaissance Lighting, Winona Lighting

Outdoor Lighting: American Electric Lighting, Antique Street Lamps, Hydrel, Tersen

Controls: DARK TO LIGHT, Lighting Control & Design, ROAM, Sensor Switch, Synergy

Acuity Brands Lighting, Inc. assumes no responsibility for claims arising out of improper or careless installation or handling of its products.

ABL LED General Warnings, Form No. 503.203
© 2010 Acuity Brands Lighting, Inc. All rights reserved. 12/01/10

INSTALLATION INSTRUCTIONS

4" - 4BL, 4G1 Baffle and Gimbal LED Modules

5" - 5BL, 5G1 Baffle and Gimbal LED Modules

6" - 6BL, 6G1 Baffle and Gimbal LED Modules

WARNING: Prior to installing the fixture, disconnect ALL power supplies to the unit. To prevent wiring damage or abrasions, do not expose wiring to edges of sheet metal or other sharp objects. This module may be installed into TYPE IC or NON-IC installations. For TYPE NON-IC INSTALLATION ONLY: No insulation may be placed over the top of or within 3" (76mm) of the fixture.

The retrofit kits is accepted as a component of a luminaire where the suitability of the combination shall be determined by CSA or authorities have jurisdiction. The contents of the retrofit kits are:

- LED Module
- Socket Adaptor
- Two Red Splice Connectors
- Instruction Sheet

WARNING: RISK OF FIRE OR ELECTRICAL SHOCK. Install this kit only in the luminaires that has the construction features and dimensions shown in the photographs or drawings.

INSTALLATION – 4" LED MODULES (Model# 4BL AND 4G1)

(NOTE – pictures show L Series Baffle modules, but installation process for LED Gimbal Modules is identical)

Retrofit 4" Installation with Socket Adaptor into Existing or New Construction Recessed Can:

1. Remove the existing lamp and reflector, leaving the socket hanging freely by the wires. (Figure 1)
2. Securely screw socket adapter into socket inside the can. While supporting the LED module, plug the orange connector of socket adaptor into the LED module's mating orange connector.

DO NOT LET THE MODULE HANG UNSUPPORTED BY THE ORANGE CONNECTORS. (Figure 2)

3. Once all connections are complete, gently push the LED trim into the recessed can opening until clips engage inside of can, and the trim is flush with the ceiling surface.

NOTE: If installing into a retrofit-style housing with internal ceiling support clips, be sure to offset the clips on the trim with the clips inside can.

4. INSTALLATION COMPLETE.

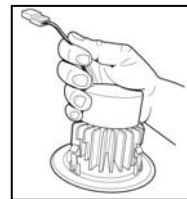

Figure 2

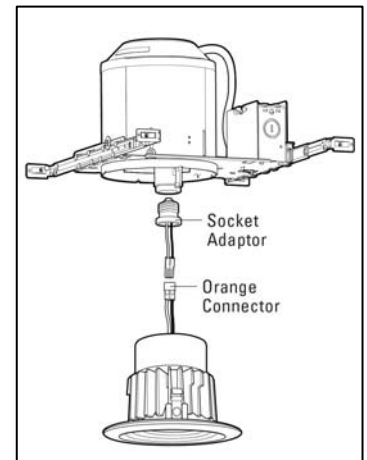

Figure 1

Retrofit 4" Installation with Hardwire Connection Kit:

1. Remove the existing lamp and reflector, leaving the socket hanging freely by the wires
2. Cut existing socket wires inside the recessed can close to the socket, and discard the socket.
3. Remove the socket adapter from the box. Cut both adapter wires close to the socket adapter and away from the orange connector, and discard the socket. Remove the (2) red splice-connectors from the hardwire kit bag. Pair the housing and orange connector wires by color into each red connector. Firmly squeeze the metal U-shaped insert into the wires. Flip the cover closed to secure and insulate the connection. (See Figure 3)

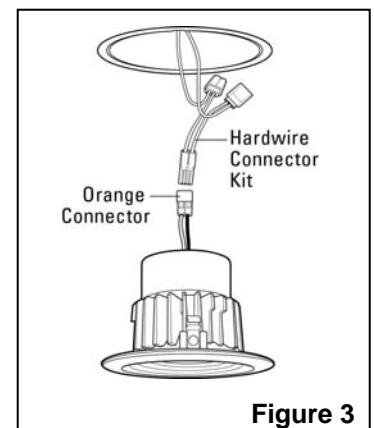

Figure 3

INSTALLATION INSTRUCTIONS

4" - 4BL, 4G1 Baffle and Gimbal LED Modules

5" - 5BL, 5G1 Baffle and Gimbal LED Modules

6" - 6BL, 6G1 Baffle and Gimbal LED Modules

- While supporting the LED module, plug connector from the module into the mating connector just installed into the recessed can. Push the wires and mated connectors up into the recessed can. **DO NOT LET THE MODULE HANG UNSUPPORTED BY THE ORANGE CONNECTORS.** (See Figure 2)
- Once all connections are complete, gently push the LED trim into the recessed can opening until clips engage inside of can, and the trim is flush with the ceiling surface.

NOTE: If installing into a remodeler-style recessed can with internal ceiling support clips, be sure to offset the trim clips away from the black clips inside can.

- INSTALLATION COMPLETE.

INSTALLATION – 6" AND 5" LED BAFFLE AND GIMBAL MODULES (BAFFLE MODEL# 6BL AND 5BL; GIMBAL MODEL# 6G1 AND 5G1)

(NOTE - pictures show L Series Baffle modules, but installation process for LED Gimbal Modules is identical.)

Retrofit 5" and 6" Installation with Edison Base Socket Adaptor into Existing or New Construction Recessed Can:

- Remove the existing lamp and reflector, leaving the socket hanging freely by the wires.

NOTE: If your can does not have (2) torsion spring retention brackets inside, see the "Torsion Spring Adapter" section prior to going further.

- Securely screw socket adapter into socket inside the can. Plug the orange connector of socket adapter into the LED module's mating orange connector. (Figure 4)

DO NOT LET THE MODULE HANG UNSUPPORTED BY THE ORANGE CONNECTORS. (Figure 5)



Figure 5

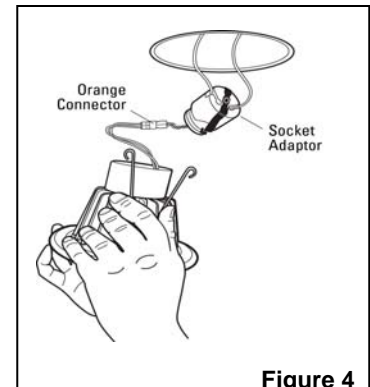

Figure 4

- Once all connections are complete, squeeze each pair of torsion springs together and seat inside of brackets in fixture. Release springs, and gently push trim into fixture until flush with ceiling. (Figure 6)

- INSTALLATION COMPLETE.

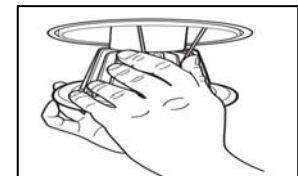

Figure 6

Retrofit 5" and 6" Installation with Hardwire Connection Kit:

- Remove the existing lamp and reflector, leaving the socket hanging freely by the wires.

NOTE: If your can does not have (2) torsion spring retention brackets inside, see the "Torsion Spring Adapter" section prior to going further.

- Cut existing socket wires inside the recessed can close to the socket, and discard the socket.
- Remove the socket adapter from the box. Cut both adapter wires close to the socket adapter and away from the orange connector, and discard the socket. Remove the (2) red splice-connectors from the hardwire kit bag. Pair the housing and orange connector wires by color into each red connector. Firmly squeeze the metal U-shaped insert into the wires. Flip the cover closed to secure and insulate the connection. (See Figure 7)

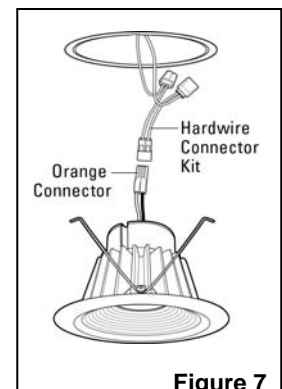

Figure 7

INSTALLATION INSTRUCTIONS

4" - 4BL, 4G1 Baffle and Gimbal LED Modules

5" - 5BL, 5G1 Baffle and Gimbal LED Modules

6" - 6BL, 6G1 Baffle and Gimbal LED Modules

4. Plug orange connector from the module into the mating orange connector just installed into the recessed can. Push the wires and mated connectors up into the recessed can. DO NOT LET THE MODULE HANG UNSUPPORTED BY THE ORANGE CONNECTORS. (See Figure 5)
5. Once all connections are complete, squeeze each pair of torsion springs together and place into brackets inside fixture. Releases springs, and gently push trim into fixture until flush with ceiling. (See Figure 6)
6. INSTALLATION COMPLETE.

Torsion Spring Adapter (TSA5 and TSA6 sold separately):

WARNING - RISK OF FIRE OR ELECTRIC SHOCK. Luminaires wiring, power supply, or other electrical parts may be damaged when drilling for installation of retrofit assembly hardware. Inspect wiring and components for damage. Only those open holes indicated in the photographs and/or drawings may be made or altered as a result of kit installation. Do not leave any other open holes in an enclosure of wiring or electrical components.

You may require the TSA5 (5") or TSA6 (6") (Figure 8) option if you are retrofitting an old-style can or a remodeler that does not have torsion spring brackets.

1. Remove the (3) screws around the perimeter inside of your existing can and keep them. **NOTE: IF THERE ARE NO SCREWS TO REMOVE, YOU WILL HAVE TO TEMPORARILY REMOVE CAN FROM CEILING TO DRILL HOLES.**

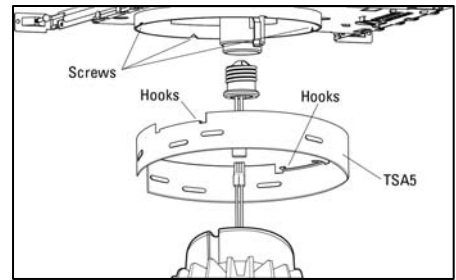

Figure 8

Drilling Holes for TSA5 or TSA6 (Remodeler-Style Cans)

- 1a. Unlock ceiling clips and remove remodeler can from ceiling.
- 1b. Supporting the can while suspended, temporarily insert the TSA5 or TSA6 bracket, hooks upward, inside the can and flush with the edge of the can.
- 1c. Using the TSA5 or TSA6 bracket-slots as a template, mark (3) hole locations with a center punch or writing utensil inside can.
- 1d. Drill three appropriate sized holes to accommodate the (3) screws, and reinstall can into ceiling.
2. Reinsert the TSA5 or TSA6 into the can with the hooks facing upward. Line up the slots with the holes and align the bottom of the TSA5 or TSA6 flush with the can.
3. Drive the (3) screws through the TSA5 or TSA6 bracket-slots and into the can to secure into position.
4. Refer back to the "INSTALLATION – 5" and 6" LED MODULE" section for further instruction.

RECOMMENDED DIMMING SWITCHES

The Lithonia LED Modules are compatible with standard incandescent (Triac), electronic low voltage (ELV), and magnetic low voltage (MLV) dimmers. A list of recommended dimmers, to help with your installation, can be found on www.lithonia.com by searching for 4BL, 5BL, 6BL, 4G1, 5G1, or 6G1. Exclusion from the list does not mean a dimmer will not work in conjunction with our LED modules, just that it has not been tested by Lithonia Lighting. It is also recommended that you contact your specific dimmer manufacturer for any details or concerns since each dimmer and application is unique.

INSTALLATION INSTRUCTIONS**4" - 4BL, 4G1 Baffle and Gimbal LED Modules****5" - 5BL, 5G1 Baffle and Gimbal LED Modules****6" - 6BL, 6G1 Baffle and Gimbal LED Modules****RECESSED CAN COMPATIBILITY**

Lithonia's LED modules were tested to fit in a minimum enclosure of 4.0" diameter by 4.90" height, while having a maximum diameter (for flange coverage) of 4.125", for the 4" LED module and 5.35" diameter by 5.31" height, while having a maximum diameter (for flange coverage) of 6.25", for the 5" LED module. 6" LED modules are tested to fit in a minimum enclosure of 6.0" diameter by 5.75" height, with a maximum flange diameter of 7.5". This was selected to provide fitment into most industry housings available. For our complete (but not exhaustive) competitive housing compatibility list, please go to www.lithonialighting.com and search for 4BL, 5BL, 6BL, 4G1, 5G1, or 6G1.

LISTINGS

CSA certified to US and Canadian safety standards; Energy Star qualified; California Title 24 compliant; damp location listed; and WSEC ASTEM E283 for Air-Tight rated with IC housings.

WARRANTY

Lithonia Lighting warrants LED products sold hereunder to be free from defect in manufacturing, under normal and proper storage, installation, and use, for a period of five (5) years from the date of shipment. Our guarantee liability extends only to the repair or replacement of the defective part, and no labor charges for correction of the defect by repair or replacement will be paid by Lithonia Lighting unless prior written authority has been granted by contacting our Post Sale department at 1-800-315-4935.