

Maestro® Dual-Circuit Occupancy Sensing Switch Additional Programming, Installation, and Troubleshooting Help

Maestro® Dual-Circuit Occupancy Sensing Switch Models

MS-OPS6-DDV; MS-PPS6-DDV

Overview

This document serves as a supplement to the Maestro® Dual-Circuit Occupancy Sensing Switch instruction sheet.

Note: For performance specifications, see the Dual-Circuit Occupancy Sensing Switch spec submittal (P/N 369748) at www.lutron.com/occvacsensor

Dual-Circuit Occupancy Sensing Switch (shown without faceplate)

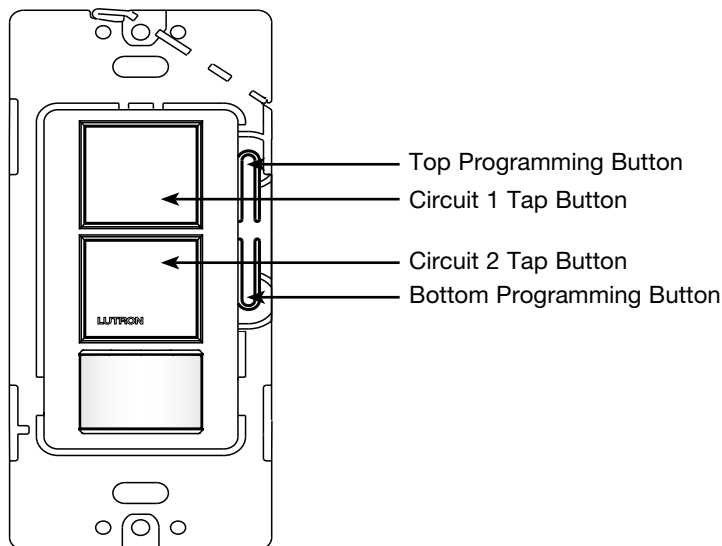

Glossary	Page 2
Explanation of Sensing Switch Features.....	Page 3
Sensing Switch Coverage Area	Page 6
Sensing Switch Programming	Page 7
Additional Programming Options	Page 9
Restoring Default Settings.....	Page 9
Wiring Diagrams	Page 10
Ambient Light Detect (ALD) - How it Works	Page 11
Troubleshooting.....	Page 13

WARNING! Shock Hazard. May result in serious injury or death. For bulb replacement or rewiring, power MUST be disconnected at the main electrical panel

Glossary

Ambient Light Detect (ALD) – When in this setting, the Sensing Switch turns each "Auto-ON" (Occupancy) circuit on upon initial occupancy to the room only if there is NOT enough ambient light. The sensor will learn your preferred light level over time, through your interactions with the Tap button, and eventually will only turn the lights on, when motion is detected and there is not enough light in the room. This setting is known as "Ambient Light Detect" mode. For more details on ALD mode, see section "Ambient Light Detect (ALD) – How it Works" on page 11.

Auto-ON / Auto-OFF (Occupancy Mode) – This is the default setting for Circuit 1 of your sensor. The sensor automatically turns on when you enter the room, and turns off when you vacate the room. This setting is also known as "Occupancy" mode.

Default Settings – Original preset programming options that the Sensing Switch is programmed to upon initial use.

Load – The light bulb(s) or fan(s) that the Sensing Switch is controlling.

Manual-ON / Auto OFF (Vacancy Mode) – This is the default setting for Circuit 2 of your sensor. The Sensing Switch will only turn on when the Tap button is pressed, but will still turn off automatically, when you vacate the room. This setting is also known as "Vacancy" mode.

Off-While-Occupied (OWO) Disabled – The sensor automatically turns on when you enter the room, and turns off when you vacate the room. When in this mode, if you turn the lights off while in the room, they will automatically turn back on after a 25 second period, if motion is detected.

Off-While-Occupied (OWO) Enabled – The sensor automatically turns on when you enter the room, and turns off when you vacate the room. When this mode is enabled, if you turn the lights off when you enter the room, they will remain off as long as the room remains occupied, and the Timeout has not expired.

Sensitivity – A programmable setting to adjust the level of sensitivity your sensor will have to detect motion.

Timeout – A programmable setting that determines how long the lights will remain on after the room has been vacated, and motion has not been detected.

Zone Mapping – A programmable setting that allows you to change your lighting zone assignments and settings.

Maestro® Dual-Circuit Occupancy Sensing Switch Programmable Features

The Sensing Switch has many features to allow you to set the unit to meet your individual needs. The following is an overview of all the product features.

Explanation of Sensing Switch Features

Timeout: The approximate time (in minutes) after which the lights will go out after the last motion is detected. The Timeout can be adjusted to 1, 5, 15, or 30 minutes. Typically, a shorter Timeout should be used in a smaller room or a location where the duration of stay is short. Conversely, a longer Timeout should be used in a larger room or a location where the duration of stay is long. The default Timeout is 15 minutes.

What do I want?

The ideal Timeout for an application may vary depending on the size of the room in which the unit is installed. The position of the sensor in relation to activity as well as the typical duration of stay will influence your desired Timeout setting. The longer you plan on occupying a room, the longer the value the Timeout should be set. For most conference rooms and offices, a Timeout of no less than 5 minutes is advised, to ensure the desired light level is maintained throughout occupancy of the space.

In applications where the Sensing Switch is controlling fluorescent or CFL bulbs, a Timeout of no less than 15 minutes is recommended to maintain bulb life.

Sensor Mode: The automatic functionality of the sensor can be adjusted to control how the lights respond upon initial occupancy. There are two available Sensor Modes: Auto-ON/Auto-OFF (Occupancy Mode), and Manual-ON/Auto-OFF (Vacancy Mode)

- **Auto-ON / Auto-OFF (Occupancy Mode):** The lights will always turn on when occupancy is detected.
Manual Off (Exit Time Delay): After the unit is manually turned off, the Auto-ON feature will be disabled for 25 seconds, even if motion is detected. This is to provide occupants time to exit larger rooms after manually turning the lights off. The unit can be manually turned on at any time. After 25 seconds, the unit will return to normal operation.
- **Manual-ON / Auto-OFF (Vacancy Mode):** This setting converts the sensor to vacancy mode. The lights will not automatically turn on but will still automatically turn off after vacancy. The lights must be manually turned on by pressing the desired Tap button on the Sensing Switch.

What do I want?

- If you want the lights to automatically turn on when someone enters the room, the sensor mode should be set to "Auto-ON / Auto-OFF (Occupancy mode)."
- If you prefer that the lights only turn on when the Tap button is pressed, choose Manual-ON / Auto-OFF (Vacancy Mode). The unit will only turn off automatically, when occupancy is no longer detected. Bedrooms are a typical application where Manual-ON mode would work better than Auto-ON mode for most users.

Explanation of Sensing Switch Features (continued)

Advanced Auto-ON Mode: Auto-ON modes can be customized to respond to different daylight and occupancy situations. These options will determine the way in which all circuits set to "Auto-ON / Auto-OFF" will respond, upon initial occupancy. The three available Advanced Auto-ON modes are: Ambient Light Detect (ALD), Off-While-Occupied Enabled (OWO), and Off-While-Occupied Disabled.

- **Ambient Light Detect (ALD):** The lights of all "Auto-ON" (Occupancy) circuits will turn on when occupancy is detected and ambient light is too low. If the lights turn on when there is already enough natural light, press the Tap button corresponding to that circuit within 5 seconds of entering the room to turn those lights off. If the lights do NOT turn on when there is NOT enough natural light in the room, press the Tap button of your Auto-ON circuit(s) within 5 seconds of entering the room to turn the lights on. The Sensing Switch will learn from these interactions and will eventually only turn the lights on when there is not enough natural light in the room, based on your preference.
- **Off-While-Occupied (OWO) Enabled:** The lights of all "Auto-ON" (Occupancy) circuits will turn on when occupancy is detected. If the lights are manually turned off, the sensor will keep those lights off as long as the room is occupied. This is the default setting of the Advanced Auto-ON Modes.
- **Off-While-Occupied (OWO) Disabled:** The lights of all "Auto-ON" (Occupancy) circuits will turn on when occupancy is detected. If the lights are manually turned off, the sensor will wait for 25 seconds before trying to detect occupancy again. The 25 second period is designed to allow occupants to exit a room without re-triggering the lights, but still provide the necessary Auto-ON functionality for high-traffic areas.

What do I want?

- If you want the lights to automatically turn on when someone enters the room, and your application is a high-traffic area (bathroom, hallway, etc), Off-While-Occupied Disabled is recommended, to keep the sensor as responsive to brief occupancy as possible.
- If you want the lights to automatically turn on when someone enters the room, but you also would like to be able to turn the lights off and have them stay off while the room is occupied (i.e. conference room presentations, movies, etc), then Off-While-Occupied Enabled (OWO), should be kept as your Advanced Auto-ON Mode. It is also likely that your Timeout for this application should be greater than 5 minutes, to increase the chances of maintaining an occupied status in situations where movement is minimal.
- If you want the lights to remain off when there is already enough natural light in the room, Ambient Light Detect mode should be enabled to maximize energy savings. This mode should not be used if the sensor switch has a circuit controlling a fan load in "Auto-ON" (Occupancy) mode, as the fan will then respond based on natural light, as well. The user(s) must be prepared to correct the sensor with the Tap button if the lights do not respond as expected, upon entering the room.

Sensitivity: The sensitivity of the sensor can be adjusted based on the expected level of activity in the room. The sensitivity setting is "High-Sensitivity," by default, and will perform best for most applications. Rarely, if the sensor is placed near external sources such as heating and cooling vents, it may turn the lights on without occupancy. If this occurs, changing the setting to "Low-Sensitivity" should resolve the problem. The default setting is "High-Sensitivity."

- **High-Sensitivity:** This is the most sensitive setting and will detect very slight motions. This is the recommended setting, as it will work well for nearly all applications.
- **Low-Sensitivity:** This is the least sensitive setting and is best used in areas of major or large motions.

What do I want?

The type of activity and amount of foot traffic will help dictate at which setting the sensor should be set. High-Sensitivity is recommended for spaces where the occupants will often be seated for long periods of time and performing fine motions such as turning a page. Low-Sensitivity is recommended for spaces that generally only experience large motions such as foot traffic.

Additionally, if the sensor sees a specific area that is not desired (ex: a hallway outside of the room in which the sensor is installed), Lutron offers a lens mask kit (Lutron P/N 50013614) that can be ordered through Tech Support (1.800.523.9466). Alternatively, selectively placing opaque tape (painters tape, electrical tape, masking tape, etc.) over certain parts of the lens can limit its field of vision to block undesired detection areas.

Explanation of Sensing Switch Features (continued)



Zone Mapping: Zone Mapping is an additional programming option that allows the user to swap the assignments of the lighting zones (swap Circuit 1 with Circuit 2). This programming step will allow a user to swap BOTH the button assignment of each zone AND the functionality of that zone. This can be used to avoid having to re-wire the Sensing Switch, if the user would prefer that the zones be switched from their current configuration.

What Do I Want?

- If you have a Partial-ON (MS-PPS6-DDV-XX) Sensing Switch, and you would like your lighting zones to be swapped from their current configuration, this is an ideal solution to avoid re-wiring the unit. You can switch your Occupancy (Auto-ON / Auto-OFF) zone with your Vacancy (Manual-ON / Auto-OFF) zone to get the desired setting for your application.
- If you have an Occupancy (MS-OPS6-DDV-XX) Sensing Switch, and you decide that you would like your button assignments to be swapped, you may use zone mapping to swap the button assignments. Keep in mind that your settings will also be swapped, so you may need to reprogram the settings for each circuit, after swapping the buttons, to ensure that you end up with the settings you want.

Sensing Switch Coverage Area

NEMA WD7 Test Grid Coverage (High-Sensitivity Setting)

-  Major motion coverage: 900 ft² (81 m²)
-  Minor motion coverage: 400 ft² (36 m²)

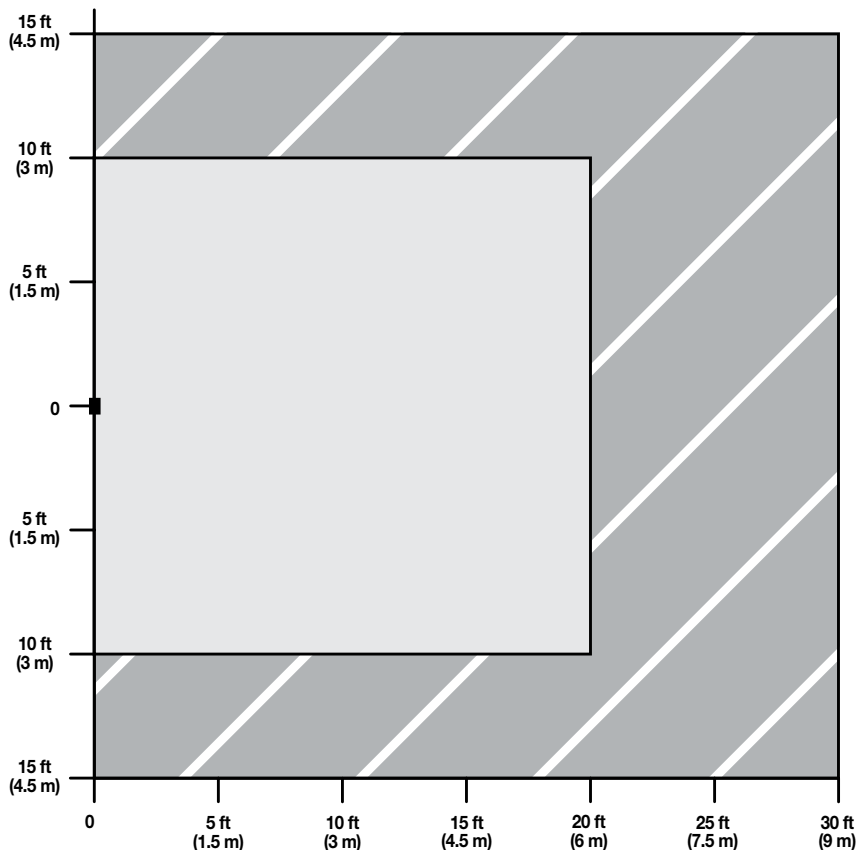

Horizontal Beam Diagram

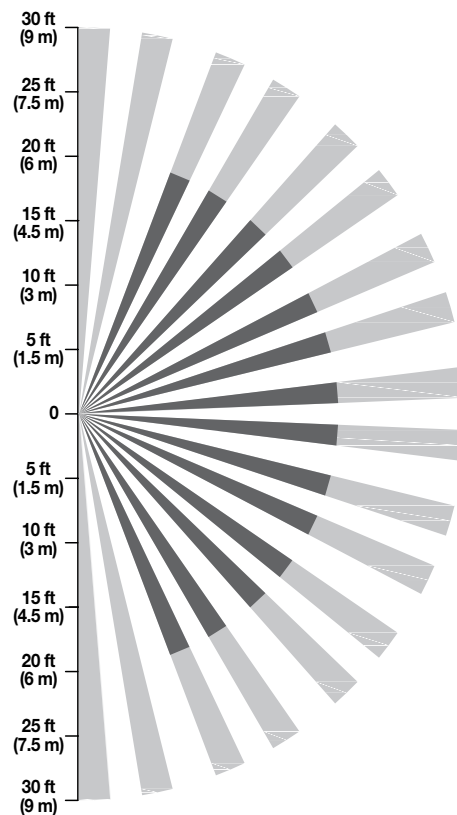

Vertical Beam Diagram

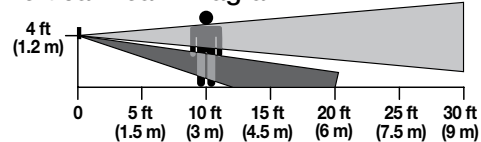

Dual-Circuit Sensing Switch Programming

Important note before programming:

All programming modes except for "Timeout" will require that you remove the faceplate before programming, to gain access to the programming buttons.

Selecting a Timeout Duration

1. Hold the Tap button of the desired circuit to adjust the Timeout for that circuit.
2. Count the number of times the lens flashes and release the button after the desired Timeout setting has been reached.

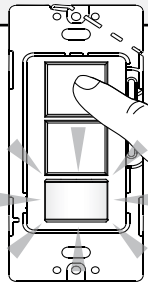
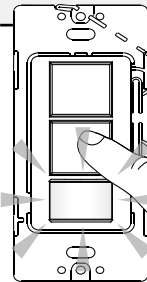
		Circuit 1		Circuit 2	
Total number of flashes	1	Test Mode *		Test Mode *	
	2	1 minute		1 minute	
	3	5 minutes		5 minutes	
	4	15 minutes		15 minutes	
	5	30 minutes		30 minutes	

Note on Shortcut: If the desired Timeout for both circuits is identical, both Tap buttons may be held to program the Timeout on both circuits simultaneously.

* **Test Mode** is a temporary, short Timeout (less than 15-seconds) that can be used to test the sensor's coverage. After entering test mode, the device will exit test mode automatically after 5 minutes, or when any button is pressed. If no motion is detected, the light will turn off. If motion is detected, the light will turn on and continue to stay on for as long as motion is detected. The lens will flash periodically, indicating that motion has been detected.

Selecting a Sensor Mode

1. Hold the programming button that corresponds with the appropriate circuit (top programming button corresponds with Circuit 1, bottom programming button corresponds to Circuit 2).
2. Count the number of times the lens flashes and release the button after the desired sensor mode has been selected.

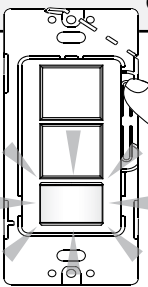
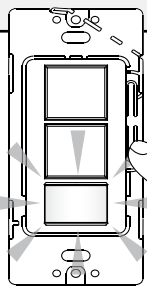
		Circuit 1		Circuit 2	
Total number of flashes	1	Auto-ON/Auto-OFF (Occupancy mode)		Auto-ON/Auto-OFF (Occupancy mode)	
	2	Manual-ON/Auto-OFF (Vacancy mode)		Manual-ON/Auto-OFF (Vacancy mode)	

Note: Holding both programming buttons simultaneously will NOT speed up programming. This is the method for programming "Advanced Auto-ON Modes" (see page 8).

Default Settings: Auto-ON / Auto-OFF for Circuit 1; Manual-ON / Auto-OFF for Circuit 2. If you have purchased an MS-PPS6-DDV-XX model ("Partial-ON"), your sensor modes are locked. If you wish to change lighting zone assignments, please see "Swapping Zone Assignments" on page 9.

Dual-Circuit Sensing Switch Programming (continued)

Selecting Advanced Auto-ON Mode

1. Hold both programming buttons.
2. Count the number of times the lens flashes and release both buttons after the desired setting has been selected.

Advanced Auto-ON Modes	
Total number of flashes	1 Ambient Light Detect (ALD)
	2 Off-While-Occupied (OWO) Enabled
	3 Off-While-Occupied Disabled

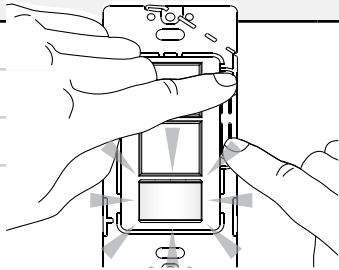

Note: This setting will apply to ALL circuits set to Auto-ON / Auto-OFF (Occupancy) mode, and will not apply to any circuits set to Manual-ON / Auto-OFF (Vacancy) mode. If ALD is selected, the unit will learn from interactions with any circuit set to Auto-ON mode.

Default Setting: Off-While-Occupied (OWO) Enabled

Selecting the Sensitivity

1. Hold the bottom Tap button and the bottom programming button simultaneously.
2. Count the number of times the lens flashes and release the button after the desired sensitivity has been selected.

Sensitivity	
Total number of flashes	1 Low
	2 High
	3 Restore ALL settings to default

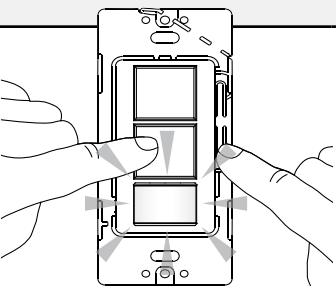

Note: The third flash will reset ALL settings on the unit to factory default. There will be significant delay between the 2nd and 3rd flashes. This is to ensure settings are not accidentally reset while programming sensitivity.

Default Setting: High-Sensitivity.

Additional Programming Options

Swapping Zone Assignments:

1. Hold both Tap buttons AND the top programming button.
2. Count the number of times the lens flashes and release all buttons after the desired setting has been selected.

Zone Mapping	
Total number of flashes	1 Default Circuit Mapping
	2 Swapped Circuit Mapping

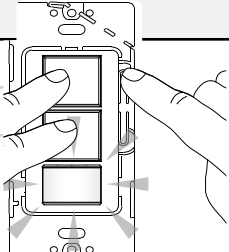

Notes:

- Zone swapping will change BOTH the button assignments (top Tap button will now be bottom Tap button) AND the zone functionality (Circuit 1 and 2 would swap settings as well).
- To zone swap back to previous settings, release the button after the first flash for Default Circuit Mapping.

Default Setting: Default Circuit Mapping (not Swapped).

Restoring Default Settings

The Sensing Switch has the ability to be returned to its original factory settings. This ability allows the programmer a risk-free experience to try multiple setting styles without worry.

Note: The default settings are:

Circuit 1 Timeout.....	15 minutes
Circuit 2 Timeout.....	15 minutes
Circuit 1 Sensor Mode	Auto-ON / Auto-OFF (Occupancy Mode)
Circuit 2 Sensor Mode	Manual-ON / Auto-OFF (Vacancy Mode)
Advanced Auto-ON Mode.....	Off-While-Occupied (OWO) Enabled
Sensitivity	High-Sensitivity
Zone Mapping	Default Circuit Mapping

To Restore Factory Defaults:

Perform programming for "Selecting the Sensitivity" (see page 8) and wait until the third flash. The third flash will be significantly delayed from the first two flashes.

Wiring Diagrams

1 Turn power OFF

⚠ WARNING! Shock Hazard. May result in serious injury or death. Turn power OFF at circuit breaker(s) before installing the unit.

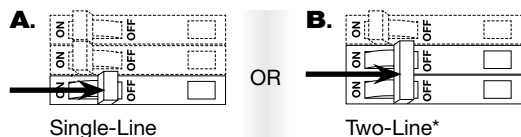

* Wiring must comply with 2011 NEC code 210.7 for wiring Multiple Branch Circuits: Where two or more branch circuits supply devices or equipment on the same yoke, a means to simultaneously disconnect the ungrounded conductors supplying those devices shall be provided at the point at which the branch circuits originate.

2 Connect dual-circuit Sensing Switch

A. Single-Line Wiring

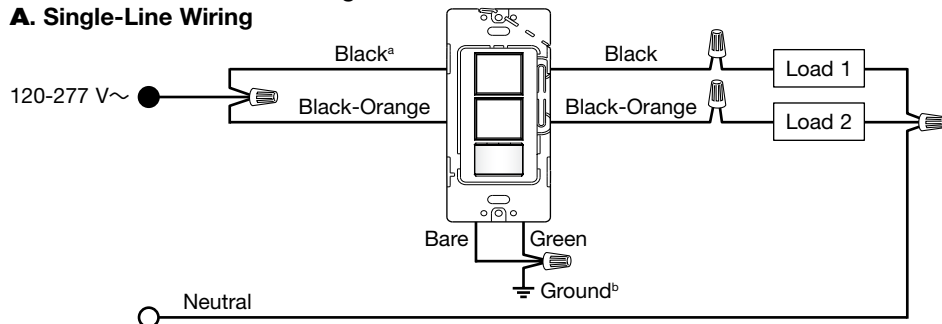

B. Two-Line Wiring

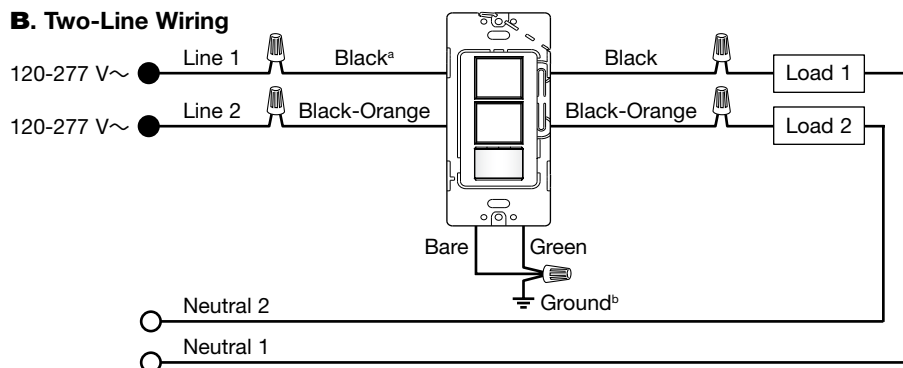

^a Device will not function if Black wires (Circuit 1/Line 1) are not wired.

^b Device will not function if it is not grounded.

NOTES:

- Leave wallplate off if custom settings are desired.
- The Dual-Circuit Occupancy Sensing Switch was designed for wiring flexibility. When wiring Circuit 1, you may use either black wire to connect to the line or load side. When wiring Circuit 2, you may use either black-orange wire to connect to the line or load side.
- Please note that both black wires correspond to Circuit 1, and both black-orange wires correspond to Circuit 2.
- If replacing existing switches with this product, it is recommended that you label the wires AFTER turning power OFF (Step 1), but BEFORE removing the previously installed switches and proceeding with wiring the Dual-Circuit Occupancy Sensing Switch

3 Turn Power ON

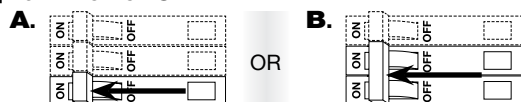

4 Wait for 2 minutes

NOTE:

After restoring power to the unit, when wiring is complete, the unit will not manually control the load for the first 30 seconds after power-up. The unit will also not operate the sensor until 2 minutes after power-up.

Ambient Light Detect (ALD) – How it Works

Ambient Light Detect (ALD) is a feature that allows you to maximize the cost savings due to lighting by keeping lights off when there is enough natural light in a space to provide adequate lighting.

Lutron's ALD feature learns your preference as you live with the product in your space. The learning algorithm utilizes user inputs to determine when ambient light is not enough.

Will my sensor utilize ALD?

Your sensor will utilize ALD if you've selected "Ambient Light Detect (ALD) Mode" while programming your unit. Some models of Lutron's in-wall sensors allow you to change the Auto-ON settings independently of ALD. In those models, you must have ALD and Auto-ON / Auto-OFF (Occupancy Mode) both enabled.

How does the sensor learn my preference?

Whenever you enter a room with a Lutron in-wall sensor utilizing the ALD feature, the sensor will either turn the lights on, or keep the lights off, based on its current light level threshold set in ALD. If you enter the room, and the lights do not respond as you'd like, you need only to press the Tap button on your unit to turn lights on (or off, if that was your preference) within 5 seconds of entering the room. The sensor has now learned a new light threshold for ALD. Here is an example to illustrate the learning process:

1. You enter the room, the lights stay off, and you decide you want the lights ON...there is not enough ambient light in the space for you.
2. You press the Tap button (within 5 seconds of entering room).
3. The unit has learned your preference for when lights should turn on, and adjusted its threshold accordingly.

If I press a button AFTER 5 seconds of being in a room, will my unit "learn" that preference?

No, you must interact within the first 5 seconds of entering the room.

How many times do I have to interact with the sensor to get it to remember my settings?

The sensor typically learns the appropriate threshold in 6-10 interactions or less.

I believe I'm using ALD correctly, but I'm still not getting the response I expect. What could be happening?

- You may have multiple users with widely different preferences. If multiple users continue to "teach" the unit separate preferences, it will continue to try to adjust to meet the threshold, but may be stuck somewhere in between the preferences of the two users.
- You may be trying to apply this feature to an application that is not exposed to daylight. This feature is designed to respond to natural light. It will not necessarily respond with the same sensitivity to synthetic light sources that operate on different wavelengths.
- You may not be able to reach your unit within 5 seconds. If your interactions do not happen within 5 seconds, you may not be teaching the unit a new threshold, and this lack of interaction may be reinforcing the current threshold (because it thinks you like the current setting).

Ambient Light Detect (ALD) – How it Works in Your Dual-Circuit Occupancy Sensing Switch

In the Dual-Circuit Occupancy Sensing Switch, Ambient Light Detect (ALD) is a setting that applies to the unit as a whole, NOT to individual circuits. Any circuit that has been set to Auto-ON / Auto-OFF (Occupancy) mode will operate under the ALD setting, if that setting is selected in “Advanced Auto-ON Modes.”

How does the sensor learn my preference?

The Dual-Circuit Occupancy Sensing Switch learns the same way as any single-circuit product with this feature. It is important to note that the sensor will ONLY learn from interactions with circuits set to Auto-ON / Auto-OFF (Occupancy) mode.

Will the sensor learn faster if I press both buttons when I enter?

No, the sensor will learn from any interaction with any Auto-ON/ Auto-OFF (Occupancy) circuit within the first 5 seconds of entering a room.

I believe I’m using ALD correctly in my Dual-Circuit product, but I’m still not getting the response I expect. What could be happening?

- Please make sure that the button(s) you press when you enter the room correspond to a circuit set to “Auto-ON / Auto-OFF (Occupancy) mode.” The sensor will NOT learn from interactions with any circuit in “Manual-ON / Auto-OFF (Vacancy) mode.”
- If you have set your fan load to “Auto-ON / Auto-OFF (Occupancy) mode,” your fan may be responding based on daylight in the room. Unless this is desired, it’s likely that many of the interactions with this fan load are NOT based on the light level of the room, and the unit’s learned threshold is being affected by these interactions.

NOTE:

Lutron advises all customers using ALD to keep fan loads on Manual-ON / Auto-OFF (Vacancy) mode, to make sure the learned threshold is not affected by unintentional interactions with the fan load.

Troubleshooting - Dual-Circuit Occupancy Sensing Switch

Symptom	Possible Cause	Likely Solution
After installation, unit is unresponsive to button(s) presses	Switches will not be active for the first 30 seconds after installation.	Please wait 30 seconds after restoring power before attempting to use Tap buttons.
	Wiring may be incorrect, or the green wire is not connected to Ground.	Refer to wiring diagrams on instruction sheet and at www.lutron.com/DCSensorInstall for directions on how to wire your product.
After installation, sensor does not seem to function	Sensor will not be active for the first 2 minutes after installation.	Please wait 2 minutes after restoring power for the sensor to become operational.
	Wiring may be incorrect, or the green wire is not connected to Ground.	Refer to wiring diagrams on instruction sheet and at www.lutron.com/DCSensorInstall for directions on how to wire your product.
After installation or following power failure, the lights will turn ON suddenly after the lights are manually turned OFF	The sensor takes up to 2 minutes to perform a calibration following a power cycle. If the lights are OFF and the calibration completes while the space is occupied, the lights will turn ON.	Wait at least 2 minutes for the calibration to complete.
Lights do not turn ON when space is occupied	Sensor mode(s) are set to Manual-ON (Vacancy) mode.	Refer to "Custom Settings" on your instruction sheet to set your Sensor Mode(s) to "Auto-ON / Auto-OFF."
	Ambient Light Detect (ALD) mode has been selected in "Advanced Auto-ON Modes" and the light level in the room is too bright.	Turn the lights ON within 5 seconds of entering the room to teach your sensor that it should turn on at the current light level. Alternatively, you could change your advanced Auto-ON mode to: Off-While-Occupied Disabled, or Off-While-Occupied Enabled. This will disable the Ambient Light Detect (ALD).
	Sensor does not have full view of room and its occupants. Room may be too large for this application.	Move objects blocking sensor's line-of-sight. You must be able to see the sensor for the sensor to "see" you.
	Advanced Auto-ON Mode: Off-While-Occupied Enabled (OWO) and unit was recently manually turned off.	Refer to "Custom Settings" on your instruction sheet to set your Advanced Auto-ON Mode to Off-While-Occupied Disabled or exit room and wait for sensor to Timeout, or manually turn light back on with Tap button.
	Wiring may be incorrect	Refer to wiring diagrams on instruction sheet and at www.lutron.com/DCSensorInstall for directions on how to wire your product.
Lights turn back ON after they are manually turned OFF	Advanced Auto-ON Mode: Off-While-Occupied Disabled has been selected. The lights will continue to turn back on 25 seconds after the lights are manually turned off, if the space is still occupied.	Use the instruction sheet's "Custom Settings" instructions to change your Advanced Auto-ON Mode to Off-While-Occupied Enabled (OWO) or Ambient Light Detect (ALD) mode.
Lights turn OFF while the space is occupied	Sensor's Timeout is too short for this application (if Timeout is set to 1 minute, and you are not moving much for 1 minute, the sensor may Timeout without motion).	Refer to "Custom Settings" on your instruction sheet to increase your Timeout duration.
	Sensor does not have full view of room and its occupants.	Move objects blocking sensor's line-of-sight. You must be able to see the sensor for the sensor to "see" you.
	Sensor's sensitivity is set to "Low"	Refer to "Custom Settings" on your instruction sheet to change sensitivity to "High."
Lights stay ON after a space is vacated	Sensor's Timeout has not yet expired	Refer to "Custom Settings" on your instruction sheet to reduce your "Timeout" setting, if the current setting lasts too long.
	Sensors mounted close to doorways can respond to motion outside of the room.	Use "Test Mode" (found in "Timeout" settings) to determine which areas are triggering the sensor to respond when not desired. Selectively cover parts of the lens with electrical tape, or with the lens mask (Lutron Part Number 50013614), which can be ordered through Tech support (1-800-523-9466).
		Refer to "Custom Settings" on your instruction sheet to change sensitivity to "Low."
	Motion is being detected from an external noise source such as an HVAC vent.	Use "Test Mode" (found in "Timeout" settings) to determine which areas are triggering the sensor to respond when not desired. Selectively cover parts of the lens with electrical tape, or with the lens mask (Lutron Part Number 50013614), which can be ordered through Tech support (1-800-523-9466).
		Refer to "Custom Settings" on your instruction sheet to change sensitivity to "Low."
Lights turn ON in Manual-ON (Vacancy) mode	Lights can turn on in the 15 second "grace period" following Timeout.	This grace period is intended to allow a user to move after lights go out, if they want the lights to come back on. If you'd like to verify that the unit is functioning properly, wait 30 seconds AFTER the Timeout has expired before re-entering the room, to verify that the lights do NOT turn ON.
	Sensor mode may be set to something other than Manual-ON (Vacancy) mode.	Refer to "Custom Settings" on your instruction sheet to change your sensor mode.

Lutron and Maestro are registered trademarks of Lutron Electronics Co., Inc.

Lutron Contact Numbers

WORLD HEADQUARTERS USA

Lutron Electronics Co., Inc.
7200 Suter Road
Coopersburg, PA 18036-1299
TEL: +1.610.282.3800
FAX: +1.610.282.1243
Toll-Free: 1.888.LUTRON1
Technical Support: 1.800.523.9466
intsales@lutron.com

EUROPEAN HEADQUARTERS United Kingdom

Lutron EA Ltd.
6 Sovereign Close
London, E1W 3JF United Kingdom
TEL: +44.(0)20.7702.0657
FAX: +44.(0)20.7480.6899
FREEPHONE (UK): 0800.282.107
Technical Support: +44.(0)20.7680.4481
lutronlondon@lutron.com

ASIAN HEADQUARTERS Singapore

Lutron GL Ltd.
15 Hoe Chiang Road
#07-03, Tower 15
Singapore 089316
TEL: +65.6220.4666
FAX: +65.6220.4333
Technical Support: 800.120.4491
lutronsea@lutron.com

North & South America Technical Hotlines

USA, Canada, Caribbean:
1.800.523.9466
Mexico:
+1.888.235.2910
Central/South America:
+1.610.282.6701

Asia Technical Hotlines

Northern China: 10.800.712.1536
Southern China: 10.800.120.1536
Hong Kong: 800.901.849
Indonesia: 001.803.011.3994
Japan: +81.3.5575.8411
Macau: 0800.401
Taiwan: 00.801.137.737
Thailand: 001.800.120.665853
Other Countries: +65.6220.4666