



MasterColor® CDM MR16

Philips MasterColor® CDM-MR16 combines the familiar compact shape of MR-16 halogen lamps with the performance of ceramic metal halide MasterColor lamps.

Features

- Energy savings—up to 2 times less energy consumed than standard 50W halogen MR-16 lamps with comparable light output
- Long life—12,000 hours rated average life*, 4 times longer than standard 3000 hour 50W halogen MR-16 lamps
- Lamp-to-lamp color consistency
- GX10 twist-and-lock design locks base into place
- Miniturized reflector eliminates need for optical design
- Available in 25 Watts with 10, 25, and 40 degree beam spreads.
- *Rated average life is the life obtained, on the average, from large representative groups of lamps in laboratory tests under controlled conditions at 10 or more operating hours per start. It is based on survival of at least 50% of the lamps and allows for individual lamps or groups of lamps to vary considerably from the average.

Benefits

- Philips MasterColor CDM MR16 is 100% compatible with existing HID systems in the market today.
- Compact size suitable for open fixtures.
- Beam spreads available in 10, 25 and 40 degrees.

Applications

- Ideal for accent/decorative lighting, general lighting and downlighting in retail applications; or for outdoor landscaping and architectural effects.

Notes

- R "WARNING: These lamps can cause serious skin burn and eye inflammation from short wave ultraviolet radiation if outer envelope of the lamp is broken or punctured. Do not use where people will remain for more than a few minutes unless adequate shielding or other safety precautions are used. Certain lamps that will automatically extinguish when the outer envelope is broken or punctured are commercially available." This lamp complies with FDA radiation

PHILIPS

performance standard 21 CFR subchapter J. (USA:21 CFR 1040.30
Canada: SOR/DORS/80-381)

Product number	Full product name
404961	MasterColor CDM-Rm 20W/830 GX10 MR16 10D ICT
404979	MasterColor CDM-Rm 20W/830 GX10 MR16 25D ICT
404987	MasterColor CDM-Rm 20W/830 GX10 MR16 40D ICT

Legend

Column	Value	Explanation
Watts	20	
Color Code	830	CCT of 3000K
Base	GX10	
Bulb	MR16	MR 16inch/50mm
Beam Angle	10	
	25	
	40	
Packing Type	ICT	1 Lamp in a Folding Carton
Packing Configuration	6	

Basic specifications - Lamps

Product number	[Watts]	Color Code	Base	Bulb	Beam Angle [°]	Packing Type	Packing Configuration	Beam Description	Bulb Finish	Operating Position
404961	20	830	GX10	MR16	10	ICT	6	-	-	Universal
404979	20	830	GX10	MR16	25	ICT	6	-	-	Universal
404987	20	830	GX10	MR16	40	ICT	6	-	-	Universal

Product number	Rated Avg. Life [Hrs]	Ordering Code	UPC	Case Bar Code	System Power EL [W]	Lamp Wattage EL [W]	Lamp Voltage [V]	Dimmable	Mercury (Hg) Content [mg]
404961	12000 [nom]	CDM-MR16 20W/830 10D 6PK	046677404 963	500466774 04968	24 [nom]	22 [nom]	97 [min] 103 [nom] 109 [max]	No	2.4 [nom]
404979	12000 [nom]	CDM-MR16 20W/830 25D 6PK	046677404 970	500466774 04975	24 [nom]	22 [nom]	97 [min] 103 [nom] 109 [max]	No	2.4 [nom]
404987	12000 [nom]	CDM-MR16 20W/830 40D 6PK	046677404 987	500466774 04982	2.4 [nom]	22 [nom]	97 [min] 103 [nom] 109 [max]	No	24 [nom]

Product number	Approx MBCP [cd]	Color Rendering Index [Ra]	Color Temperature [K]	Initial Lumens [lm]	Initial Lumens [lm]	Overall Length C [mm]	Diameter D [mm]	Product Number
404961	- [min] 11000 [nom]	80 [min] 87 [nom]	3000 [nom]	- [min] - [nom]	900 [min] 1060 [nom]	- 65.4	50 50.7	404961



Product number	Approx MBCP [cd]	Color Rendering Index [Ra]	Color Temper- ature [K]	Initial Lumens [lm]	Initial Lumens	Overall Length C [mm]	Diameter D [mm]	Product Number
404979	- [min] 3500 [nom]	80 [min] 87 [nom]	3000 [nom]	- [min] - [nom]	900 [min] 1060 [nom]	- 65.4	50 50.7	404979
404987	- [min] 1700 [nom]	80 [min] 87 [nom]	3000 [nom]	- [min] - [nom]	900 [min] 1060 [nom]	- 65.4	50 50.7	404987

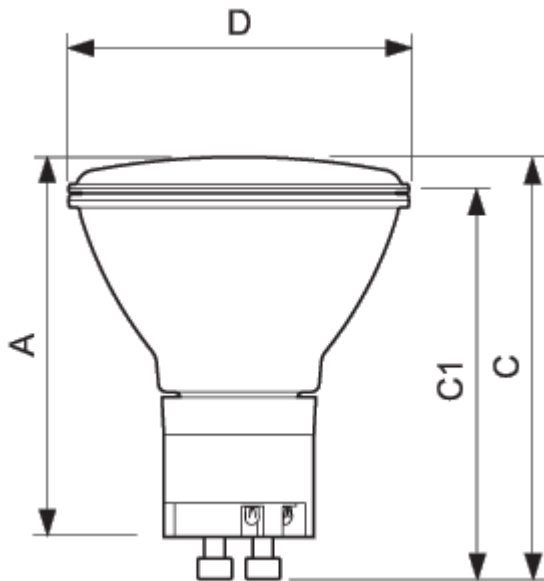

MasterColor CDM-Rm MR16 20W/830 000I

	A	C1
Dimension Reference	Max	Max
I	59	60.9

Full product name	Dimension Reference
MasterColor CDM-Rm 20W/830 GX10 MR16 40D ICT	I
MasterColor CDM-Rm 20W/830 GX10 MR16 25D ICT	I
MasterColor CDM-Rm 20W/830 GX10 MR16 10D ICT	I

Letter	Explanation
A	Reference Length A
CI	Overall Length Rim CI



MasterColor CDM-Rm MR16 20W/830 GX10 MR16 25D/40D 0001



MasterColor CDM-Rm MR16 20W/830 10D 0001

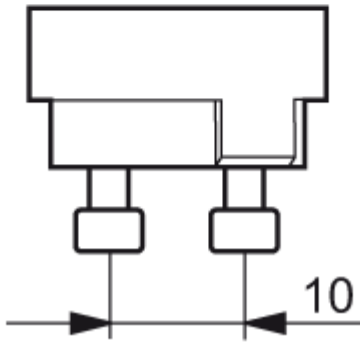
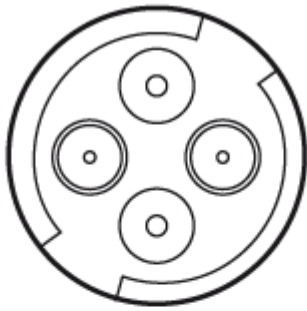

Base GX10

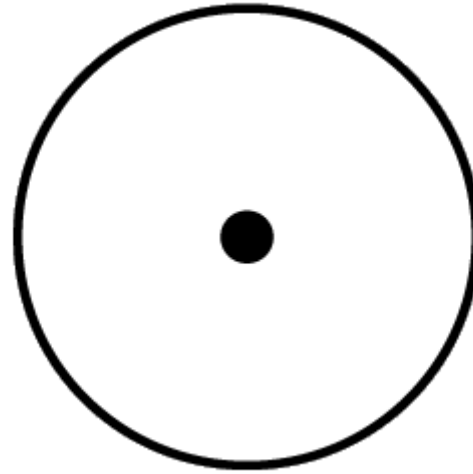

Operating Position Universal

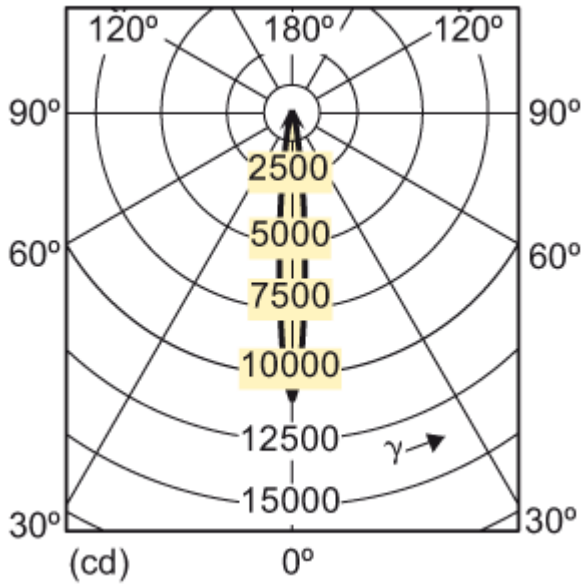

MasterColor CDM-Rm MR16 20W/830 10D 0001

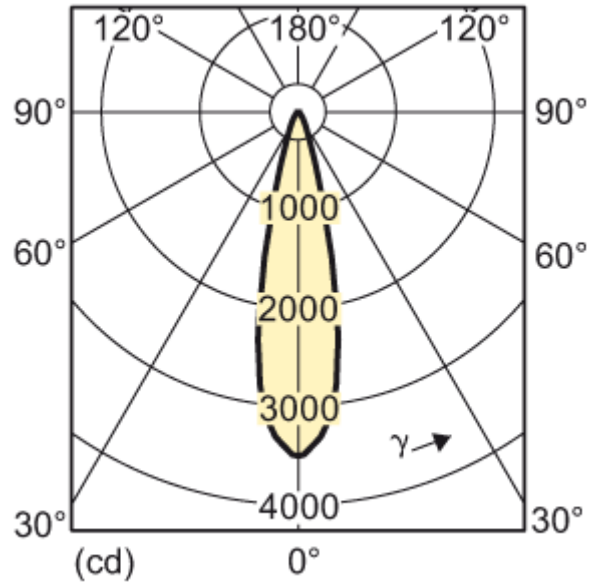

MasterColor CDM-Rm MR16 20W/830 25D 0001

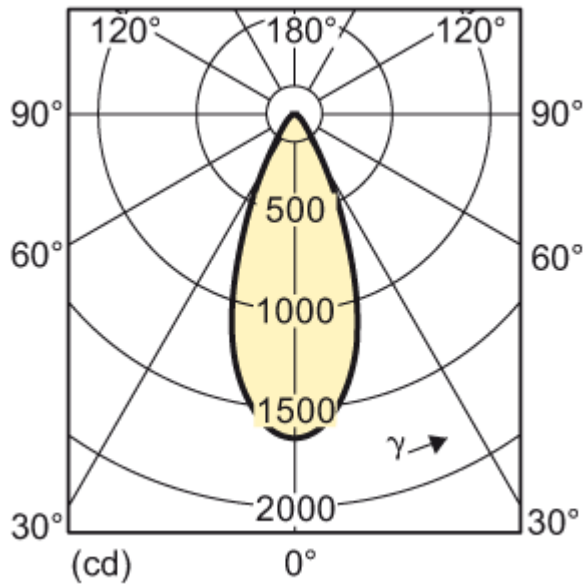

MasterColor CDM-Rm MR16 20W/830 40D 0001

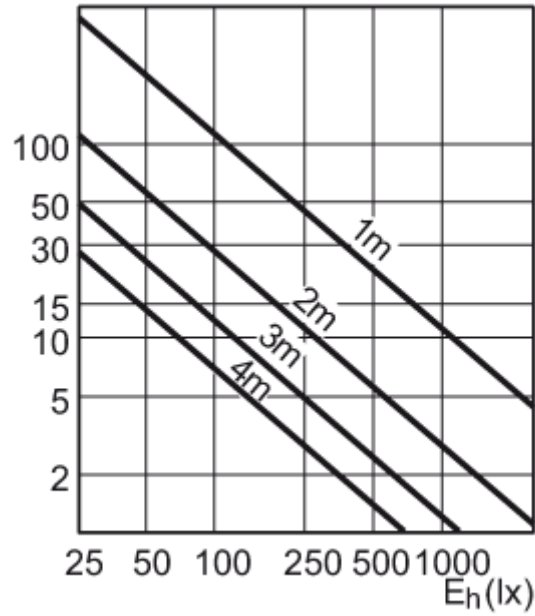

MasterColor CDM-Rm MR16 20W/830 10D 0001

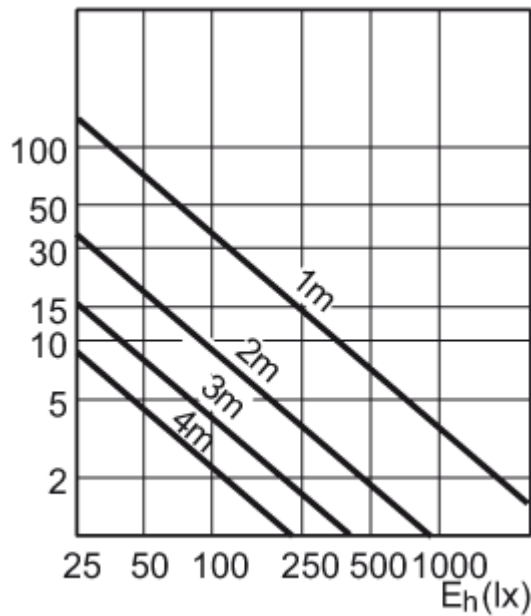

MasterColor CDM-Rm MR16 20W/830 25D 0001

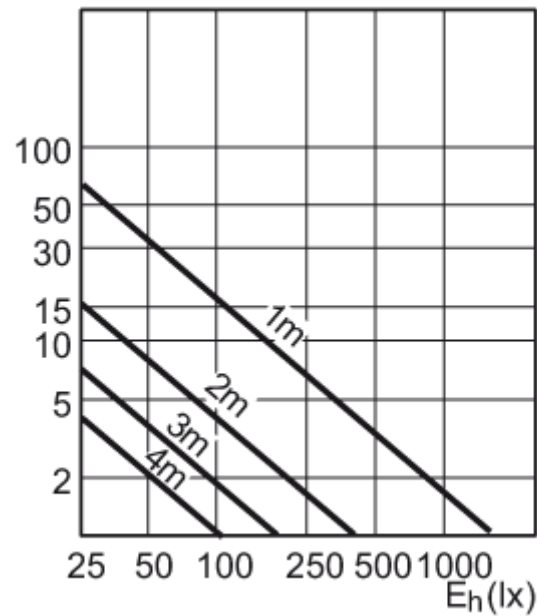

MasterColor CDM-Rm MR16 20W/830 40D 0001

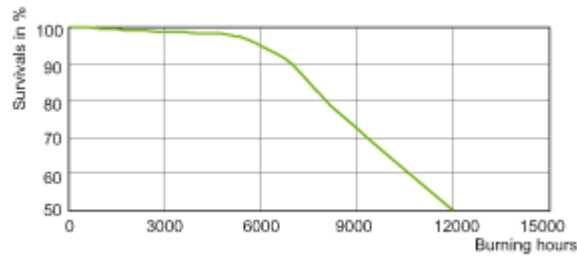

MasterColor CDM-Rm MR16 20W/830 0001

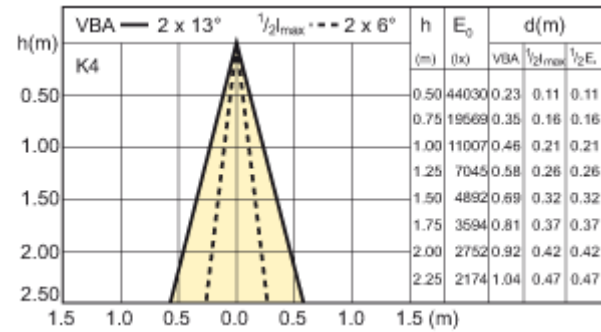

MasterColor CDM-Rm MR16 20W/830 10D 0001

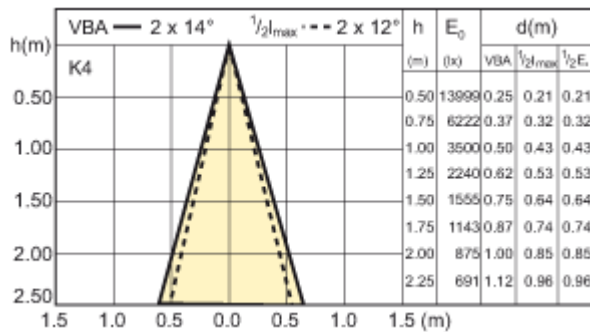

MasterColor CDM-Rm MR16 20W/830 25D 0001

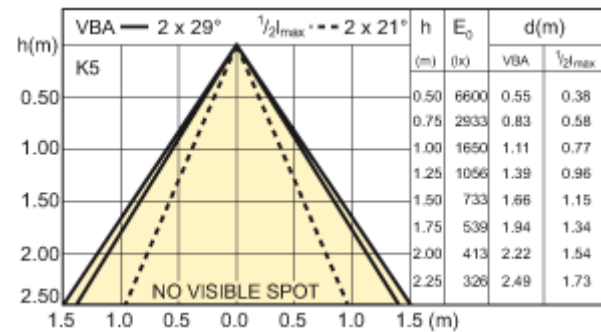

MasterColor CDM-Rm MR16 20W/830 40D 0001

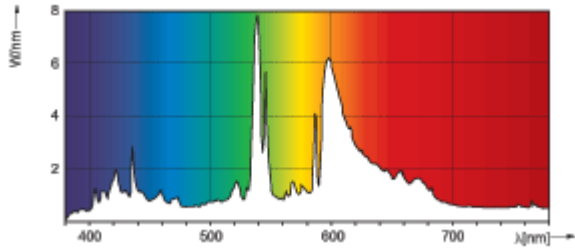

MASTERColour CDM-R Mini /830
MasterColor CDM-Rm MR16 20W/830 0001

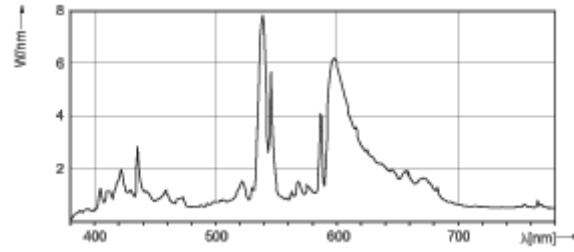

MASTERColour CDM-R Mini /830
MasterColor CDM-Rm MR16 20W/830 0001

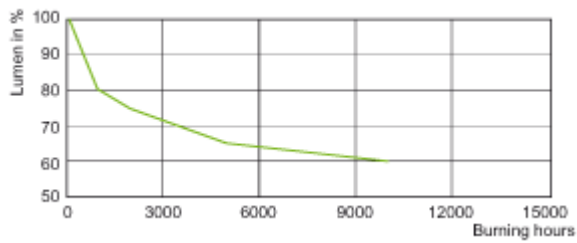

MasterColor CDM-Rm MR16 20W/830 0001

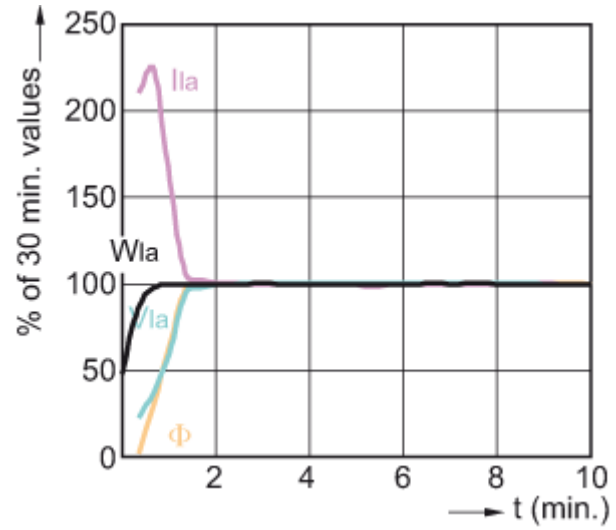

MasterColor CDM-Rm MR16 20W/830 0001



©2009 Koninklijke Philips Electronics N.V.

All rights reserved. Reproduction in whole or in part is prohibited without the prior written consent of the copyright owner. The information presented in this document does not form part of any quotation or contract, is believed to be accurate and reliable and may be changed without notice. No liability will be accepted by the publisher for any consequence of its use. Publication thereof does not convey nor imply any license under patent- or other industrial or intellectual property rights.

Document order number : 0000 000 00000