



Designer Wall Switch Occupancy Sensor Single Pole (One Location) or Multi-Location

Rated: 120/277V, 60Hz

Cat. No. ODS15-IDx

Incandescent
1800W - 15A @ 120V

Fluorescent
1800VA - 15A @ 120V

Fluorescent
4000VA - 15A @ 277V

Supplemental
1/4hp - 5.8A @ 120V

No Minimum Load Required

Compatible with electronic and magnetic ballasts,
electronic and magnetic low-voltage ballasts,
incandescent lamps, and fans.

Installation Instructions

DI-000-ODS15-00B

LIMITED FIVE YEAR WARRANTY AND EXCLUSIONS

Leviton warrants to the original consumer purchaser and not for the benefit of anyone else that this product at the time of its sale by Leviton is free of defects in materials and workmanship under normal and proper use for five years from the purchase date. Leviton's only obligation is to correct such defects by repair or replacement, at its option, if within such five year period the product is returned prepaid, with proof of purchase date, and a description of the problem to **Leviton Manufacturing Co., Inc., Att: Quality Assurance Department, 59-25 Little Neck Parkway, Little Neck, New York 11362-2591**. This warranty excludes and there is disclaimed liability for labor for removal of this product or reinstallation. This warranty is void if this product is installed improperly or in an improper environment, overloaded, misused, opened, abused, or altered in any manner, or is not used under normal operating conditions or not in accordance with any labels or instructions. There are no other or implied warranties of any kind, including merchantability and fitness for a particular purpose, but if any implied warranty is required by the applicable jurisdiction, the duration of any such implied warranty, including merchantability and fitness for a particular purpose, is limited to five years. Leviton is not liable for incidental, indirect, special, or consequential damages, including without limitation, damage to, or loss of use of, any equipment, lost sales or profits or delay or failure to perform this warranty obligation. The remedies provided herein are the exclusive remedies under this warranty, whether based on contract, tort or otherwise.

For Technical Assistance Call:
1-800-824-3005 (U.S.A. Only)
www.leviton.com

DI-000-ODS15-00B

FEATURES	
<ul style="list-style-type: none"> Leviton's Decora® style design Controls 15A of lighting load 	<ul style="list-style-type: none"> Low Profile, tamper-resistant lens Adapting time and ambient light

INTRODUCTION
Leviton Cat. No. ODS15-IDx, Designer Wall Switch Occupancy Sensor, is designed to detect motion from a heat-emitting source (such as a person entering a room) within its field-of-view (monitored space) and automatically switch lights ON and OFF. The controlled lights will remain ON until no motion is detected and the scheduled time-delay has expired. The Sensor adapts its time delay and ambient light settings to the occupancy patterns of a room.

Cat. No. ODS15-IDx is UL listed, CSA certified and conforms to California Title 24 requirements.

DESCRIPTION

The Occupancy Sensor senses motion within its coverage area of 2400 sq. ft (223.3 m²) maximum and controls the connected lighting. This is a self-contained device which provides sensing and light control. The Occupancy Sensor will turn the lights ON when motion is initially detected, and keep the lights ON for as long as motion is detected.

The Occupancy Sensor uses a small semiconductor heat detector that resides behind a multi-zone optical lens. This *Fresnel* lens establishes dozens of zones of detection. The Sensor is sensitive to the heat emitted by the human body. In order to trigger the Sensor, the source of heat must move from one zone of detection to another. The device is most effective in sensing motion across its field-of-view, and less effective sensing motion towards or away from its field-of-view (**refer to Figures 1 and 1A**). Keep this in mind when selecting the installation location (**refer to Figures 1 and 1A**).

Note that occupancy sensors respond to rapid changes in temperature, so care should be taken not to mount the device near a climate control source (i.e. radiators, air exchanges, and air conditioners). Hot or cold drafts will look like body motion to the device and will trigger it if the unit is mounted too close. **It is recommended to mount the Occupancy Sensor at least 6 ft. away from the climate control source.** The device can be mounted in a single gang wall box.

In addition, it is also recommended NOT to mount the Occupancy Sensor directly under a large light source. Large wattage bulbs (greater than 100W incandescent) give off a lot of heat and switching the bulb causes a temperature change that can be detected by the device. Mount the Occupancy Sensor at least 6 ft. away from large bulbs. If it necessary to mount the device closer, lower the wattage of the bulb directly overhead.

FCC COMPLIANCE STATEMENT

This device complies with part 15 of the FCC Rules. Operation is subject to the following two conditions: (1) This device must not cause harmful interference, and (2) This device must accept any interference received, including interference that may cause undesired operation.

INSTALLATION INSTRUCTIONS

WARNING: TO BE INSTALLED AND/OR USED IN ACCORDANCE WITH APPROPRIATE ELECTRICAL CODES AND REGULATIONS.

WARNING: IF YOU ARE NOT SURE ABOUT ANY PART OF THESE INSTRUCTIONS, CONSULT A QUALIFIED ELECTRICIAN.

WARNING: CONTROLLING A LOAD IN EXCESS OF THE SPECIFIED RATINGS WILL DAMAGE THE UNIT AND POSE RISK OF FIRE, ELECTRIC SHOCK, PERSONAL INJURY OR DEATH. CHECK YOUR LOAD RATINGS TO DETERMINE SUITABILITY FOR YOUR APPLICATION.

WARNING: DO NOT INSTALL THIS UNIT TO CONTROL A RECEPTACLE.

OTHER CAUTIONS AND NOTES:

- DISCONNECT POWER WHEN SERVICING FIXTURE OR CHANGING BULBS.
- USE THIS DEVICE WITH COPPER OR COPPER CLAD WIRE ONLY. WITH ALUMINUM WIRE USE DEVICES MARKED CO/ALR OR CU/AL ONLY.
- DO NOT TOUCH THE SURFACE OF THE LENS. CLEAN OUTER SURFACE WITH A DAMP CLOTH ONLY.
- THE CAT. NO. ODS15-IDx OCCUPANCY SENSOR IS INTENDED TO REPLACE A STANDARD LIGHT SWITCH.

TO INSTALL:

NOTE: Cat. No. ODS15-IDx requires a ground connection in order to operate. Use the ground wire in the electrical box for ground connection. If there is no ground wire, make sure the electrical box is grounded and attach the ground wire to the box with a screw.

- WARNING:** TO AVOID FIRE, SHOCK, OR DEATH: **TURN OFF POWER** AT CIRCUIT BREAKER OR FUSE AND TEST THAT THE POWER IS OFF BEFORE WIRING.
- Connect wires per appropriate WIRING DIAGRAM as follows: BLACK lead to LINE. BLUE lead to LOAD. GREEN lead to GROUND. Twist strands of each lead tightly and, with circuit conductors, push firmly into the appropriate wire connector. Screw connector on clockwise making sure that no bare wire shows below the connector. Secure each wire connector with electrical tape.
- Ensure that the Service Switch (**refer to Figure 2**) is in the AUTO position (middle position). Cat. No. ODS15-IDx must begin operation in the AUTO mode.
- Carefully position the wires into the wall box, then mount the Sensor Unit into the wall box.
- Secure device using long mounting screws provided.
- Restore power at circuit breaker or fuse.

NOTE: Cat. No. ODS15-IDx will beep once 5 seconds after power is applied. **Allow approximately 1 minute for charge-up.** After approximately 1 minute the lights will turn ON. If the lights turn ON and the LED blinks when a hand is waved in front of the lens, then the Sensor was installed properly. If the operation is different, **refer to the Troubleshooting Section.**

Cat. No. ODS15-IDx is factory preset to work without any adjustments. If you desire to change the factory settings, refer to the Settings section.

- Attach the Control Panel cover, and a Decora® Wallplate (not included). **INSTALLATION IS COMPLETE.** Leave the room and the lights will turn OFF after the selected time-out expires.

PROGRAMMING FEATURES

Factory Settings: The Sensor is shipped from the factory to work in almost all situations without any added adjustments. The factory settings are: Blinders open, Base time-out 10 minutes, Lights always turn ON regardless of existing light levels, and Maximum range.

Blinders: The blinders are two independent shutters that can narrow the field-of-view from a maximum of 180° down to 32°. The blinders are operated by moving the blinder levers towards or away from the center of the Sensor. The blinder levers can be found above the control dials in the control panel (**refer to Figure 2A**).

Time-Outs: The Sensor has three types of Time-Outs: Walk-through, Base Time, and Adapting.

- Walk-through Time-Out: The value of this time-out is preset to 2.5 minutes. It is used by the Sensor as a starting point in adjusting the other types of time-outs.

- Base Time-Out: The value of this time-out is user selected through the use of the Time Control Setting.
- Adapting Time-Out: When activated, the value of this time-out is changed by the Sensor based on room occupancy and lighting conditions.

Walk-Through: The walk-through feature is useful when a room is momentarily occupied. With this feature, the Sensor will turn the lights OFF shortly after the person leaves the room.

The walk-through feature works in the following manner: When a person enters the room, the lights will turn ON. If the person leaves the room before the default walk-through time-out of 2.5 minutes, the Sensor will turn the lights OFF. If the person stays in the room for longer than 2.5 minutes, the Sensor will instead use the time-out per the Time Control Setting (**refer to Time Control Setting in the following sections**).

The walk-through feature may be user disabled (**refer to Non-Adapting Mode in the following sections**).

Audio Warning: The Sensor is equipped with a beeper to give the user feedback of unit operation. During normal operation, the Sensor will issue three short beeps 20 seconds before the time-out is over to alert the user that the lights are going to turn OFF. The occupant must move in order for the lights to remain ON. The Sensor issues two short beeps to let the occupant know that motion was detected and that the lights will stay ON.

Adapting Time Delay: The Sensor has built in adapting intelligence that changes the adapting time-out duration in response to the occupancy conditions of the room it is installed in.

If the Sensor detects "large" motions (as a person walking by), it will NOT change the time-out duration. If the Sensor detects "small", infrequent motion (as a person sitting down and writing), it will INCREASE the Adapting Time-Out duration. If the Sensor detects "small", frequent motion (as in several persons in a room during a meeting), it will DECREASE the Time-Out duration only if it was NEVER increased (this is because the built-in intelligence will always proceed in the direction of "increasing" adapting time-out once it has increased it for any of the occupancy conditions sensed).

If the room is occupied for longer than 2.5 minutes, the Sensor will enter the Occupied Mode with the Time-Out duration specified by the Time Control Setting. This Time-Out is used as the starting point for adapting. After a few days, the Time-Out value will adapt to the "best" value based on the occupancy conditions detected in the room.

If the Sensor detects motion immediately after the audio warning beep, it will determine that the existing Time-Out value is too short. The Sensor will thus increase the Time-Out value by 1.5 times the existing value.

If the Sensor detects motion within 45 seconds after the lights turn OFF, it will turn the lights ON and increase the Time-Out value by 1.5 times the existing value.

The adapted Time-out may be reset to the base value by rotating the Time Control to a new time selection value (**refer to Figure 2A**).

Time Control Setting: The base Time-Out value is selected by rotating the Time Control dial. There are four (4) values from which to choose. Each mark around the dial corresponds to a different value as indicated below (**refer to Figure 2A**). The Sensor will beep once to indicate that a new time value has been selected.

NOTE: All time durations is approximate within ±10 seconds.

Adapting Ambient Light Override: The Ambient Light Override is used to keep the lights OFF if there is already enough natural light in the room. For proper operation, the Ambient Light Override adjustment must be performed when there is enough natural light (**refer to the Settings section**). If the adjustment is made when there is less natural light, the lights may not turn ON even though they are needed. This will require manual activation of the push-buttons to turn the lights ON.

If the Ambient Light Override Adjustment is not performed properly, the Adapting feature will adjust this setting. The Sensor will use the light level prior to turning the lights ON as the new Ambient Light value and increase it slightly so that next time the same conditions are present, it will turn the lights ON. This adapting feature may take a few cycles prior to adjusting to the proper light level.

If the Ambient Light Override is not performed, the adapting feature will not be utilized (**refer to Ambient Light Dial in the following section**).

NOTE: The ambient light level in the center of a room will be different then the level at the wall where the switch is located.

Ambient Light Dial: The ambient light setting is adjusted with the Ambient Light dial (**refer to Figure 2A**). Turning the Light Dial fully counter-clockwise (CCW), sets the Sensor to manual ON mode (lights always turn ON) (**see following section**). All other settings will cause the lights to turn ON only when the light level is less than the setting.

To prevent false low light levels from the user standing in front of the device during adjustment, the Sensor remembers the Ambient Light level from 1 minute ago.

There are two ways the Adapted Ambient Light level can be reset to the level set by the dial: **(1)** By rotating the Light Dial, the adapted value will be replaced by the new value corresponding to the new position of the dial. **(2)** By pressing and holding the button for 3 seconds; the Sensor will beep once and reset the Adapted Light Level value to the dial setting.

NOTE: When the setting is at the minimum CCW level, the lights will stay OFF when the room is dim. When the setting is at the maximum level clockwise (CW), the lights will turn ON when the room is bright.

Manual ON Mode: When the light control is in the fully CCW position the lights will never automatically turn ON. In this mode the lights need to be manually turned ON by the push-button, and will turn OFF with the absence of motion. If the light control is in the fully CW position, the lights will turn ON whenever motion is detected, even in full daylight. Intermediate settings will cause the lights to turn ON only when the ambient light is below the level selected by the light control.

NOTE: The ambient light in a room will change with the time of day and the season of the year.

RANGE: To decrease detection range and sensitivity, rotate the knob CCW (**refer to Figure 2A**). The detection range can be adjusted from 100% down to 36%.

SETTINGS

NOTE: To avoid PERMANENT DAMAGE to the unit, be careful NOT TO OVERTURN or use excessive force when setting control knobs or levers of Cat No. ODS15-IDx. Use a small straight blade screwdriver to adjust knobs and your finger to adjust the blinder levers.

- Remove the control panel cover.
- Remove the warning label that covers the adjustment dials.
- Rotate the Time dial to select the desired base time-out value.
- If the Sensor is installed within 6 feet of an air duct, rotate the Range Control 1/4 turn counter-clock-wise (CCW), otherwise, leave it at maximum.
- Set the Ambient Light Level - AMBIENT LIGHT:** Cat. No. ODS15-IDx has an adjustment to determine at what minimum ambient light level the unit will operate. The adjustment should be made when the ambient light is at the level where no artificial light is needed. Follow these steps to make a more accurate adjustment of the light control.

NOTES:

- If Manual-On mode is desired, keep the Lights knob in the fully counter-clockwise (CCW) position.
 - The manual adjustment in the next section only needs to be approximate, as it provides a starting point for the self-adjustment.
- A. If the lights are ON, press the push-button to turn the lights OFF (refer to Figure 2A).
 - B. Rotate the light knob until Cat. No. ODS15-IDx beeps. The knob must be rotated slowly so you do not overshoot the level. The sensor's light setting is now set to the light level in the room.
 - C. Press the push-button to turn the lights back ON.
 - D. Adjustments are finished. Attach the Control Panel cover, and a Decora® Wall Plate (not included). Leave the room and the lights will turn OFF after the selected time-out expires.

NOTE: When the light control is in the fully CCW position the lights will never automatically turn ON. This is the Manual-On mode, where the lights need to be manually turned ON by the push-button, and will turn OFF with the absence of motion.

If the light control is in the fully clockwise (CW) position, the lights will turn ON whenever motion is detected, even in full daylight. Intermediate settings will cause the lights to turn ON only when the ambient light is below the level selected by the light control. Cat. No. ODS15-IDx will self-adjust to find the optimal light level based on the habits of the occupants.

NOTE: The ambient light in a room will change with the time of day and the season of the year.

6. Non-Adapting Mode (Fixed Time-Out) -

- A. Rotate the Light dial full CCW.
- B. Adjust the Time dial. The Sensor will beep twice each time the Time dial is pointed at a new time-out value (for adapting mode, it beeps once). The time-out values for non-adapting mode are:

Face Marking	Value of Time
(/) Slash Mark	5 minutes base time-out
1	10 minutes base time-out
2	20 minutes base time-out
3	30 minutes base time-out

- C. Return the Light dial to its previous setting.

NOTE: To return to adapting mode, rotate the Time dial into a new setting while the Light dial is anywhere but in the full CCW position. Be sure the Time dial is rotated until a beep is issued to be sure a new time value was selected. Then return the Time dial to the desired time-out setting.

7. If desired, adjust the blinders to block any unwanted motion.
8. Replace the label and Control Panel Cover.

TO OPERATE

PUSH-BUTTON: Cat. No. ODS15-IDx has a push-button switch that will toggle the lights (refer to Figure 2). If the lights are OFF, the lights will turn ON when the button is pressed, and remain ON in the presence of motion. In the absence of motion, the Sensor Unit will time-out and turn the lights OFF.

If the lights are ON, the lights will turn OFF when the button is pressed. The lights will stay OFF regardless of motion detected, until the time-out expires. After the time-out expires, the lights will turn ON with the next detected motion. This is useful for slide or film presentations.

Service Switch: The slide switch located at bottom of Sensor has three positions: OFF, AUTO, and ON (refer to Figure 2). Note when in the OFF or ON position, the lights will not react to the push-button.

Switch	Position	Function
OFF	Left	The lights are forced OFF, regardless of occupancy state. Use for changing lamps.
AUTO	Middle	Normal occupancy sensor operation.
ON	Right	The lights are forced ON, regardless of occupancy state.

- NOTES:**
- The Motion Indicator LED will blink every 2 seconds while motion is detected.
 - In Manual-On mode, the button must be pressed to turn the lights ON. In the absence of motion, the unit will time-out and turn the lights OFF.
 - If Manual-On mode is desired, keep the Light knob in the fully counter-clockwise (CCW) position.

TROUBLESHOOTING GUIDE

1. If there is no response from the unit (the light never turns ON and the LED never blinks) 1 1/2 minutes after power is applied, then uninstall device and verify there is a ground connection at the wall box. If there is a ground connection, verify wiring.
2. If the lights never automatically turn ON, but they do turn ON from the push-button:
 - A. Check that the Service Switch is in the AUTO (middle) position.
 - B. Check if the Ambient Light Control Knob is pointed fully counter-clockwise (CCW). Rotate it clockwise (CW) until the lights turn ON.
3. If the lights constantly stay ON, even when the room is unoccupied:
 - A. Check the Time setting. See how this time compares to how long the lights stay ON.
 - B. Try lowering the Range Control. Rotate the knob CCW about 30°.
 - C. If the problem persists, try reducing again. **NOTE:** Do Not reduce so much that Cat. No. ODS15-IDx cannot see normal occupancy.
 - D. Be sure to use the Blinders to block any unwanted hallway traffic.
 - E. Check for reflected heat/motion as Sensor Unit may be seeing motion through a window.
 - F. Check for adjacent HVAC and/or heater ducts.
4. For additional information call Leviton's Technical Support Line.

Figure 1 - Field-of-View (Horizontal)

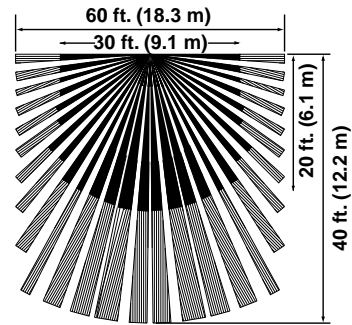

Figure 1A - Side (Vertical) Field-of-View

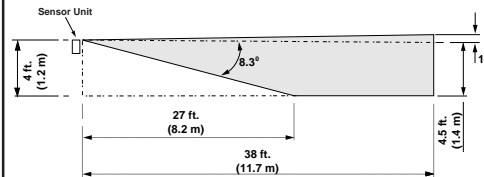

Figure 2 - Sensor Features

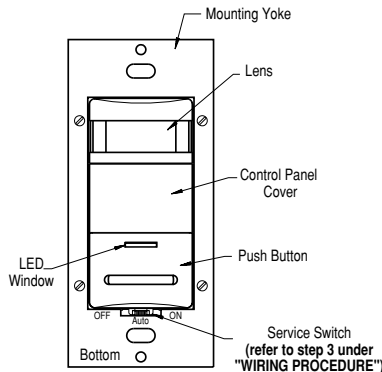
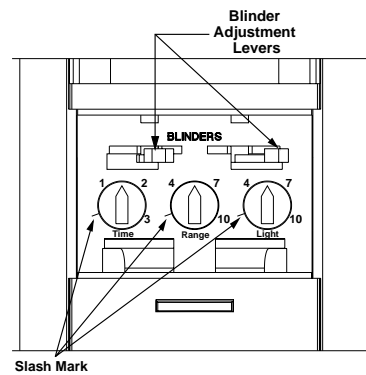
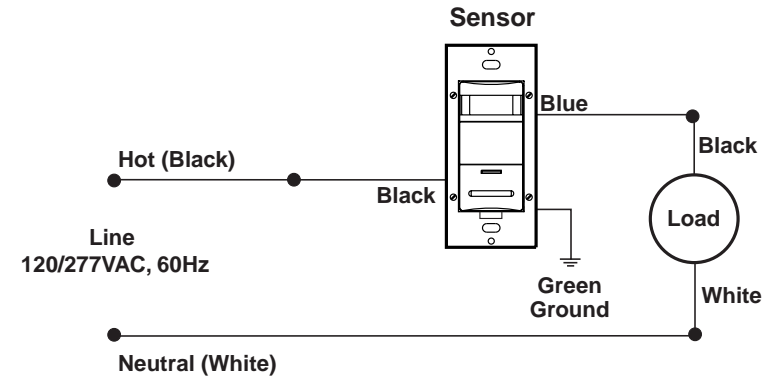

Figure 2A - Control Features



DI-000-ODS15-00B

Wiring Diagram 1 - Single Control Application



Wiring Diagram 2 - Two Location Control Application

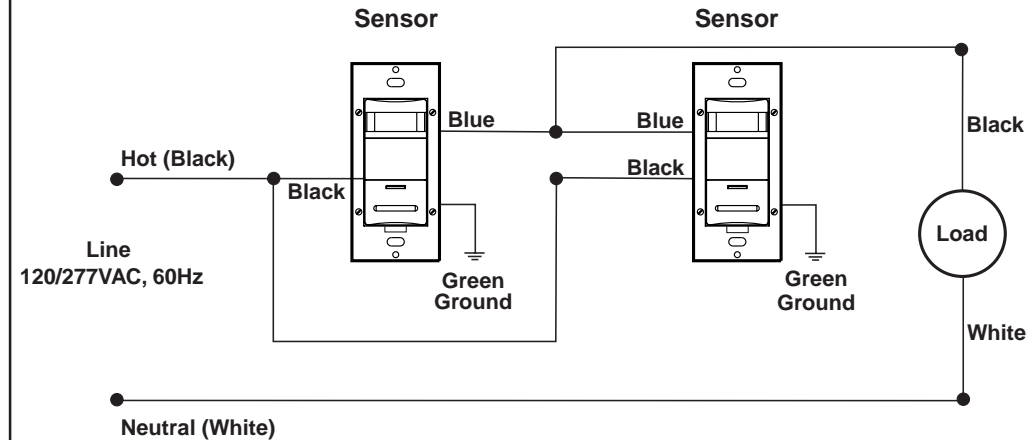

NOTE: Either Sensor can turn the lights ON. Either Sensor must time-out to OFF, or both manual buttons must be pressed for the lights to turn OFF.

FOLD SCHEME

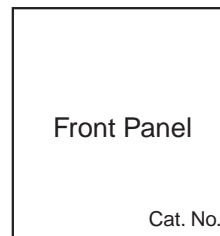
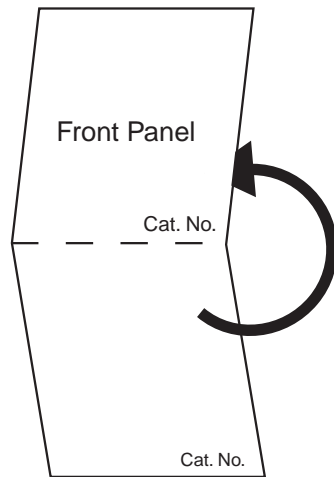
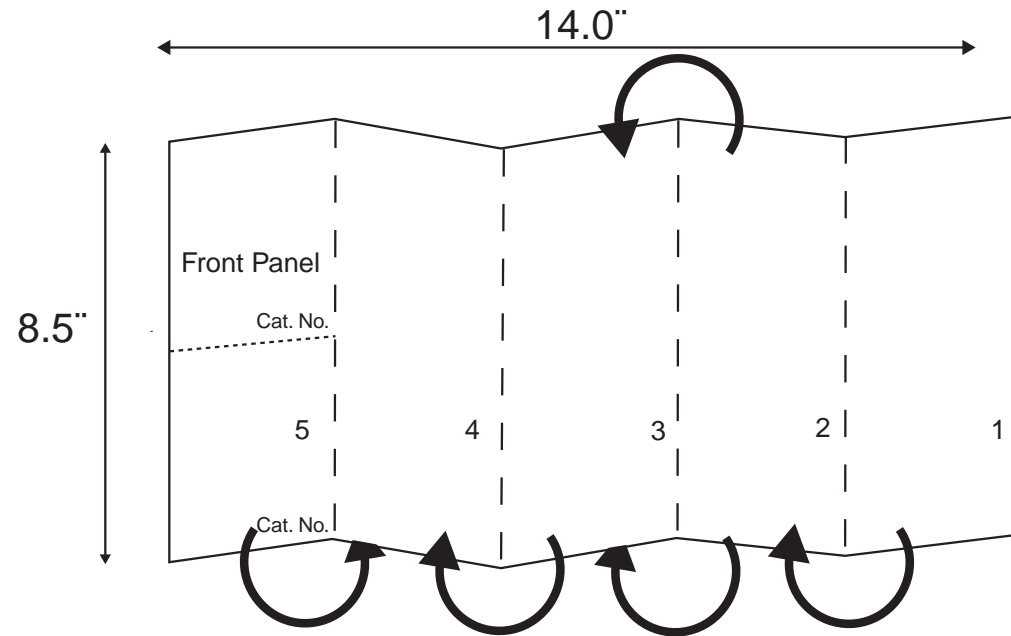

--- --- --- --- Fold Line

..... Panel Line

#'s = Fold Sequence

LEVITON INSTRUCTION SHEET/MANUAL SPECIFICATIONS

- Artwork No/Rev Level: DI-000-ODS15-00B
- Color(s): Black over
 - 1. _____ 2. _____
 - 3. _____ 4. _____
- Font Families: Helvetica
- Material
 - Type: 50 Lb. offset
- Coating: _____
- Paper size:
 - Overall size: 14" X 8.5"
 - Final fold size: 2.8" X 4.25"

DOCUMENTATION

- ECO No.: N/A
- Artist: rde Date: 03/21/02

The information in this document is the exclusive PROPRIETARY property of LEVITON MANUFACTURING COMPANY, INC. It is disclosed with the understanding that acceptance or review by the recipient constitutes an undertaking by the recipient. (1) to hold this information in strict confidence, and (2) not to disclose, duplicate, copy, modify, or use the information for any purpose other than that for which disclosed.

Copyright © 1997 Leviton Mfg. Co. Inc.
Unpublished. All Rights Reserved