

Single Pole (One location) or 3-Way (Multi-location) Fluorescent Dimmer Cat. No. VPH08-1L (Lighted) 8A-120VAC, 60Hz INSTALLATION INSTRUCTIONS

WARNINGS AND CAUTIONS:

- To be installed and/or used in accordance with appropriate electrical codes and regulations.
- If you are unsure about any part of these instructions, consult a qualified electrician.
- To avoid overheating and possible damage to this device and other equipment, use only with the appropriate Lutron 120V Hi-lume® or Eco-10® (EcoSeries) electronic ballasts for controlling the specific fluorescent lamps.
- Vizia +™ dimmers are not compatible with standard 3-way or 4-way switches. They must be used with compatible Vizia +™ remotes for multi-location dimming.
- Use only one (1) Vizia +™ dimmer in a multi-location circuit with up to 9 coordinating remotes without LEDs or up to 4 matching remotes with LEDs. The remote(s) will turn the light on at the brightness level selected at the dimmer.
- Only use lamps listed on ballast label. Compact Fluorescent lamps must have four pins for dimming.

WARNINGS AND CAUTIONS:

- Lamps must be burned in at full intensity for 100 hours prior to dimming for proper dimming performance.
- For new installations, wire a test switch before installing dimmer.
- Total minimum load must exceed 40W.
- Dimmer may feel warm to the touch during normal operation.
- Recommended minimum wall box depth is 2-1/2".
- Maximum wire length from dimmer to all installed remotes cannot exceed 300 ft.
- Disconnect power at circuit breaker or fuse when servicing, installing or removing fixture.
- Use this device only with copper or copper clad wire. With aluminum wire use only devices marked CO/ALR or CU/AL.

Tools needed to install your Dimmer

- Slotted/Phillips Screwdriver
- Electrical Tape
- Pliers
- Pencil
- Cutters
- Ruler

Changing the color of your device:

Your device may include color options. To change color of the face proceed as follows:

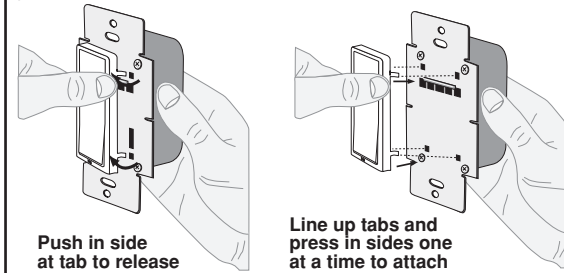

Installing Dimmer by itself or with other devices

If installing Dimmer in a single device application, proceed with the **INSTALLING YOUR DIMMER** section. If installing Dimmer in a multi-device application, proceed as follows:

MULTI-DEVICE APPLICATION

In multi-dimmer installations, the side sections of the mounting strap may require removal. Use pliers to carefully bend side sections back and forth until they break off.

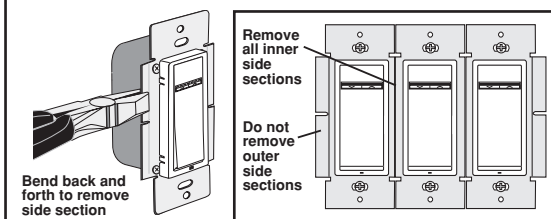

Typically, removal of the side sections in multi-dimmer installations requires a reduction of the dimmer's capacity. **However, there is no reduction necessary for this device.** Refer to the chart for maximum load per dimmer.

MAXIMUM LOAD PER DIMMER FOR MULTI-DEVICE APPLICATION			
Cat. No.	Single	Two Devices	More than 2 Devices
VPH08	8A	8A	8A

The maximum current rating is 8A, which can be measured from the incoming Hot (Black) on the dimmer. Refer to the ballast label to determine the total load on the dimmer circuit. The total load is calculated by adding all of the ballast input currents for all ballasts on dimmer.

INSTALLING YOUR DIMMER

NOTE: Use check boxes when Steps are completed.

Step 1 **WARNING: TO AVOID FIRE, SHOCK, OR DEATH; TURN OFF POWER** at circuit breaker or fuse and test that power is off before wiring!

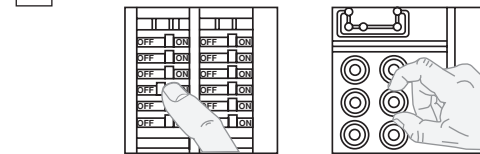

Step 2 **Preparing and connecting wires:**

Pull off pre-cut insulation from dimmer leads. Make sure that the ends of the wires from the wall box are straight (**cut if necessary**). Remove insulation from each wire in the wall box as shown.

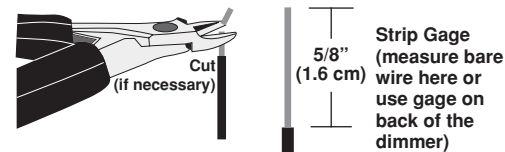

For non-standard wiring applications, refer to Wire Nut and Conductor Size Chart

WIRE NUT / # OF CONDUCTOR COMBINATION CHART
1- #12 w/ 1 to 3 #14, #16 or #18
2- #12 w/ 1 to 2 #16 or #18
1- #14 w/ 1 to 4 #16 or #18
2- #14 w/ 1 to 3 #16 or #18

Step 2 cont'd

CAUTION:

- Before installing your dimmer, check new installation wiring for any shorts in the circuit.
- Turn OFF Power at circuit breaker or fuse.
 - Using a standard switch, connect appropriate wires to Hot circuit and ballast (refer to diagram).
 - Turn ON Power. If lights do not turn ON, there is an open in the circuit.
 - If required, Turn OFF Power and correct wiring. Verify circuit again. Warranty of dimmer will be voided if dimmer is turned ON in a shorted circuit.

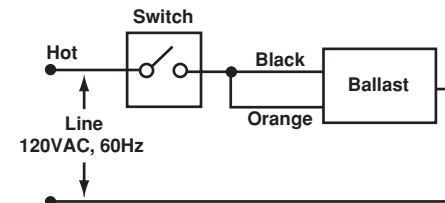

- For Single-Pole Application, go to Step 3a.
- For 3-Way Coordinating Remote (no LEDs) Application, go to Step 3b.
- For 4-Way Coordinating Remote (no LEDs) Application, go to Step 3c.
- For 3-Way Matching Remote (with LEDs) Application, go to Step 3d.
- For 4-Way Matching Remote (with LEDs) Application, go to Step 3e.

Step 3 Wiring your Dimmer:

Connect wires per **WIRING DIAGRAM** as follows: Twist strands of each lead tightly together and, with circuit conductors, push firmly into appropriate wire connector. Screw connectors on clockwise making sure no bare conductors show below the wire connectors. Secure each connector with electrical tape. For all multi-location applications, the dimmer must be installed in a wall box that has a Load connection. The remote must be installed in a wall box with a Line Hot connection and a Neutral connection.

If you are unsure about any part of these instructions, consult a qualified electrician.

NOTE: Maximum wire length from dimmer to all installed remotes cannot exceed 300 ft.

A Single-Pole Wiring Application:

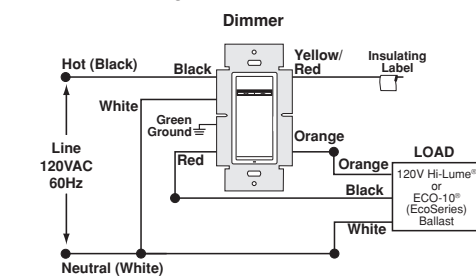
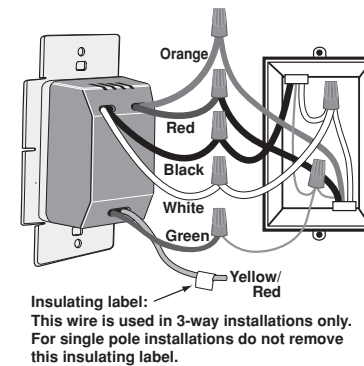

B 3-Way Wiring with Coordinating Remote (no LEDs) Application:

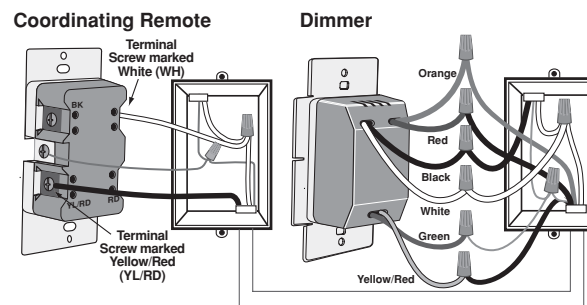

B 3-Way Wiring with Coordinating Remote (no LEDs) Application:

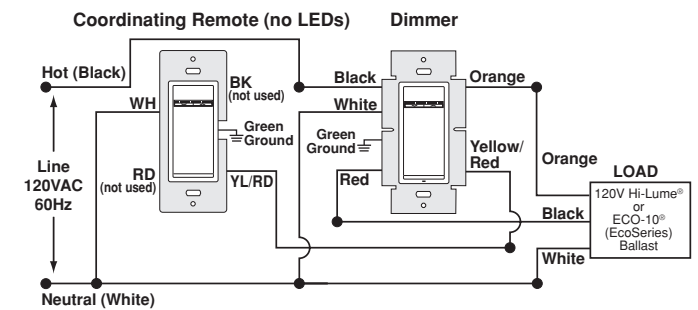

C 4-Way Wiring with Coordinating Remote (no LEDs) Application:

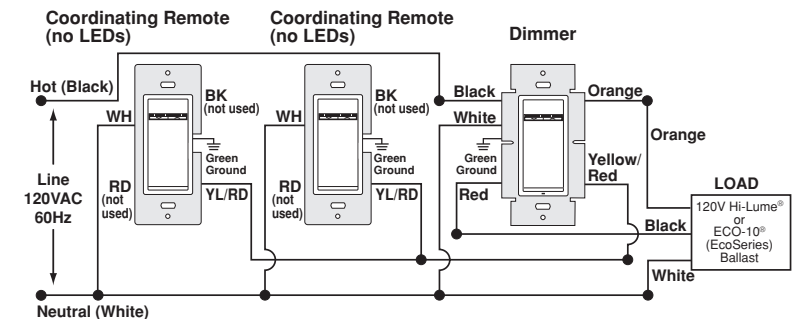
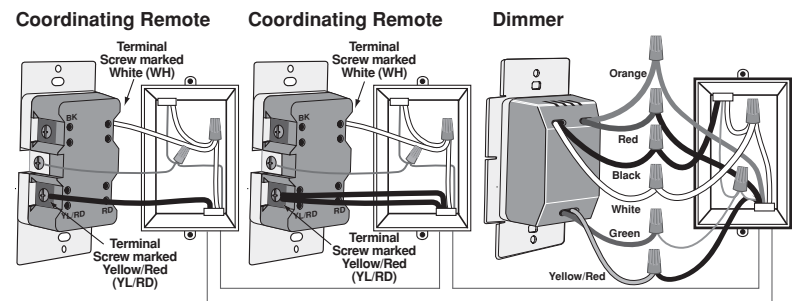

D 3-Way with Matching Remote (w/LEDs) Wiring Application:

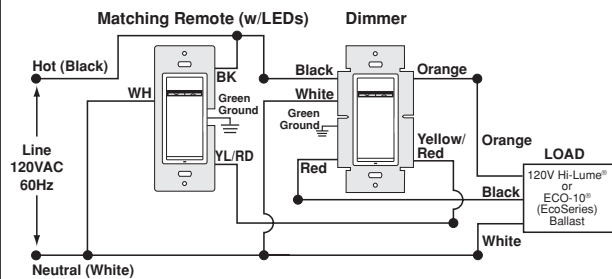
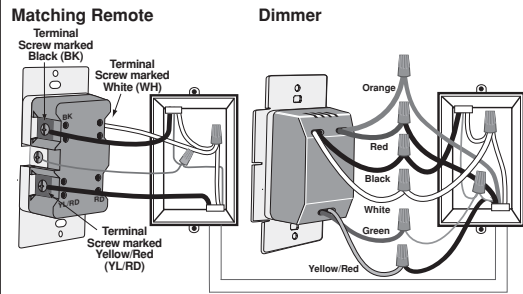

E 4-Way Wiring with Matching Remote (w/LEDs) Application:

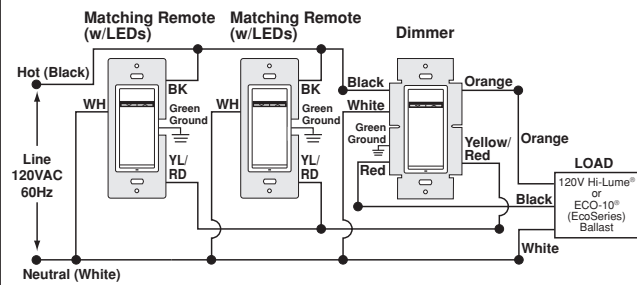
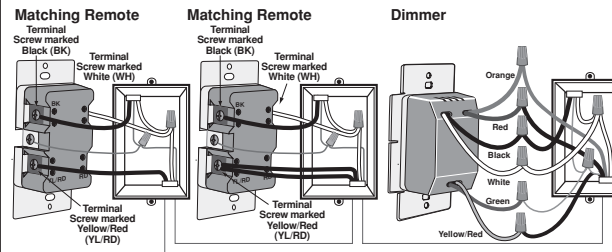

2008 © Leviton Mfg. Co., Inc.

Step 4 Testing your Dimmer prior to mounting in wall box:

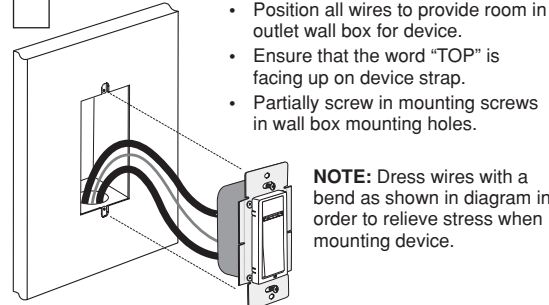

- Position all wires to provide room in outlet wall box for device.
- Ensure that the word "TOP" is facing up on device strap.
- Partially screw in mounting screws in wall box mounting holes.

NOTE: Dress wires with a bend as shown in diagram in order to relieve stress when mounting device.

If lights still do not turn ON, refer to the TROUBLESHOOTING section.

Step 5 Dimmer Mounting: TURN OFF POWER AT CIRCUIT BREAKER OR FUSE.

Installation may now be completed by tightening mounting screws into wall box. Attach wallplate.

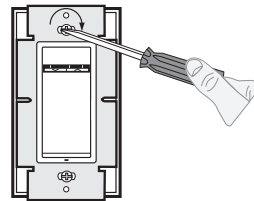

Step 6 Restore Power: Restore power at circuit breaker or fuse. Installation is complete.

OPERATION

NOTE: The locator light will illuminate when the load is in the OFF position to facilitate access in the dark.
NOTE: If using the dimmer in a 3-way application, the lights will turn ON at brightness set on dimmer's DIM/BRIGHT bar. The lighting can be controlled from either the dimmer or the remote location.

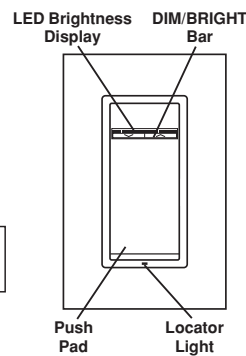

Push Pad (Default settings)

Turn ON from OFF position:
Tap – Lights turn ON to preset level.
Press and Hold – Lights turn ON to full bright.

Turn OFF from ON position:
Tap – Lights turn OFF.

DIM/BRIGHT Bar

BRIGHTEN:
Press right half of DIM/BRIGHT Bar – Lights brighten to desired level.

DIM:
Press left half of DIM/BRIGHT Bar – Lights dim to desired level. If you continue to hold the left half of the DIM/BRIGHT Bar, the lights will DIM to minimum level and then turn OFF.

NOTE: The turn on light level can be changed when lights are off using the DIM/BRIGHT Bar. In the event of power outage or interruption, the lights will reset to the last level when power is restored.

Air-Gap Switch: On the dimmer only, engage the air-gap switch by gently pressing the top of the push pad until the bottom lifts completely out of the frame and a click is heard (refer to Figure). LEDs will turn OFF. This will stop power to the fixture to replace the bulb. After servicing is complete, press the push pad back into place for normal operation.

Cleaning: Clean with a damp cloth. **DO NOT** use chemical cleaners.

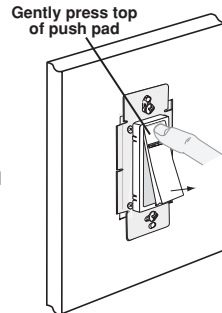

ADVANCED PROGRAMMING FEATURES

Definition of A Modes

- A-1) Energy Save:** Sets the maximum brightness level for energy savings.
- A-2) Minimum Brightness Level:** Sets the minimum dimming level.
- A-3) Preset ON Level:** Sets the turn on brightness level regardless of the previous set light level (formerly Dim Lock).
- A-4) Almost OFF Level:** Sets the brightness level the device will dim to when the push pad is pressed to turn off. In this mode the lights will always remain on.

Definition of B Modes

- B-1) ON Fade Rate:** Sets the amount of time in seconds it takes the lights to turn ON to maximum brightness.
- B-2) OFF Fade Rate:** Sets the amount of time in seconds it takes the lights to turn OFF from maximum brightness.
- B-3) LED Options:** Sets the time period in seconds the Locator LED and Brightness display will stay on before extinguishing.

Definition of C Modes

- C) Restore Defaults:** Restores the factory default settings.

Definition of LEDs

Leftmost LED = LED 1
Rightmost LED = LED 7

NOTES:

- The device will exit programming mode after 3 minutes of inactivity.
- Pressing the Push Pad at any time during programming will advance the device to the next programming mode.

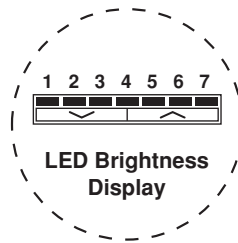

Program Mode A

To enter Program Mode A:

Press and hold the Push Pad and then the **right** half of the DIM/BRIGHT Bar (^) for 5 seconds until the Locator LED and leftmost LED (LED 1) begin to blink.

- A-1)** Upon releasing the Push Pad and the **right** half of the DIM/BRIGHT Bar (^), the Locator LED will continue to blink once per second and the rightmost LED will illuminate to display the device is in Program Mode **A-1, Energy Save**. The default energy save mode is 100% i.e. full bright. To change the **Energy Save** level, use the DIM/BRIGHT Bar to move the corresponding LED to the desired discrete preset level according to **Chart A**. By tapping the Push Pad this setting will automatically be saved and the device will advance to the next programming mode, **A-2**.

When indicator light is at LED #	Light output is at	Energy consumption savings amounts to
7	100%	0%
6	97%	5%
5	95%	8%
4	90%	11%
3	85%	14%
2	80%	17%
1	75%	20%

- A-2)** The Locator LED will blink 2 times per second to indicate the device is in Program Mode **A-2, Minimum Brightness Level**. The default Minimum Brightness Level is the LED 2. To change the **Minimum Brightness Level** from 1-50%, use the DIM/BRIGHT Bar. The light output will reflect the minimum brightness level selected. By tapping the Push Pad this setting will automatically be saved and the device will advance to the next programming mode, **A-3**.

- A-3)** The Locator LED will blink 3 times per second to indicate Program Mode **A-3, Preset ON Level**. To change the current **Preset ON Level** from 1-100%, use the DIM/BRIGHT Bar. If this feature is not desired, press and hold the **left** half of the DIM/BRIGHT Bar (v) until no LED is lit (default setting). By tapping the Push Pad this setting will automatically be saved and the device will advance to the next programming mode, **A-4**.

- A-4)** The Locator LED will blink 4 times per second to indicate Program Mode **A-4, Almost OFF Level**. To change the current **Almost OFF Level**, use the DIM/BRIGHT Bar to adjust the preset light level. If this feature is not desired, press and hold the **right** half of the DIM/BRIGHT Bar (^) until no LED is lit (default setting). **Almost OFF** can be overridden by pressing and holding the **left** half of the DIM/BRIGHT Bar (v). By tapping the Push Pad this setting will automatically be saved and the device will exit Programming Mode A.

NOTE: When **Almost OFF Level** is set the LED Locator will be illuminated when the dimmer is in the **Almost OFF** state, even though the light remains on.

Program Mode B

To enter Program Mode B:

Press and hold the Push Pad and then the **left** half of the DIM/BRIGHT Bar (v) for 5 seconds until the Locator LED and rightmost LED (LED 7) begins to blink.

- B-1)** Upon releasing the Push Pad and the **left** half of the DIM/BRIGHT Bar (v), the Locator LED will continue to blink once per second indicating he dimmer is in Program Mode **B-1, ON Fade Rate**. To change the **ON Fade Rate**, use the DIM/BRIGHT Bar to move the LED to the desired preset level according to **Chart B**. By tapping the Push Pad this setting will automatically be saved and the device will advance to the next programming mode, **B-2**.

- B-2)** The Locator LED will blink 2 times per second to indicate Program Mode **B-2, OFF Fade Rate**. To change the **OFF Fade Rate**, use the DIM/BRIGHT Bar to move the LED to the desired preset level according to the **Chart B**. By tapping the Push Pad this setting will automatically be saved and the device will advance to the next programming mode, **B-3**.

LED	FADE ON	FADE OFF
LED 1	0 seconds (instant)	0 seconds (instant)
LED 2 (Default)	0.5 seconds	0.5 seconds
LED 3	1.5 seconds	1.5 seconds
LED 4	3.0 seconds	3.0 seconds
LED 5	6.0 seconds	6.0 seconds
LED 6	10 seconds	10 seconds
LED 7	25 seconds	25 seconds

- B-3)** The Locator LED will blink 3 times per second to indicate Program Mode **B-3, LED Options**. To change the **LED Options** settings, use the DIM/BRIGHT Bar to move the LED to the desired preset setting according to **Chart B-3**. By tapping the Push Pad this setting will automatically be saved and the device will exit Programming Mode B.

LED	LOCATOR LED TIMEOUT	LED BRIGHTNESS DISPLAY OPTIONS
LED 1	Active	Active
LED 2	Active	Turns off 5 sec. after use
LED 3	Turns off 5 sec. after use	Active
LED 4	Turns off 5 sec. after use	Turns off 5 sec. after use
LED 5	N/A	N/A
LED 6	N/A	N/A
LED 7	N/A	N/A

Program Mode C

To enter Program Mode C:

Engage the air-gap switch by gently pressing the top of the Push Pad until the bottom lifts completely out of the frame and a click is heard. All LEDs will extinguish.

- C)** Press Push Pad back into the frame and hold Push Pad for 7 seconds until and the LED Brightness Display starts bidirectional strobing to indicate Program Mode **C, Restore Default**. To **Restore Default** settings, release the Push Pad. This will exit programming mode C.

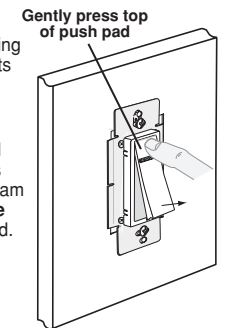

TROUBLESHOOTING

- **Lights Flickering**
 - Lamp has a bad connection.
 - Wires not secured firmly with wire connectors of dimmer or terminal screws of remote.
- **Light does not turn ON and Locator LED does not turn ON**
 - Circuit breaker or fuse has tripped.
 - Lamp is burned out.
 - Neutral not wired to dimmer (White wire).
- **Intermittent dimmer operation**
 - Minimum load is under 40W.
- **Remote does not operate lights**
 - Ensure that total wire length does not exceed 300 ft.
 - Ensure wiring is correct.
- **Light cycle ON and OFF**
 - Remove excess load.

For additional information, contact Leviton's Techline at 1-800-824-3005 or visit Leviton's website at www.leviton.com

Covered by one or more US & Foreign Patents and patents pending
Copyright © 2007 Leviton Manufacturing Co., Inc.
All Rights Including Trade Dress Rights Reserved

FCC COMPLIANCE STATEMENT

This equipment has been tested and found to comply with the limits for a Class B Digital Device, pursuant to Part 15 of the FCC Rules. These limits are designed to provide reasonable protection against harmful interference in a residential installation. This equipment generates, uses, and can radiate radio frequency energy and, if not installed and used in accordance with the instructions, may cause harmful interference to radio communications. However, there is no guarantee that interference will not occur in a particular installation. If this equipment does cause harmful interference to radio or television reception, which can be determined by turning the equipment OFF and ON, the user is encouraged to try to correct the interference by one or more of the following measures:

- Reorient or relocate the receiving Antenna.
- Increase the separation between the equipment and the receiver.
- Connect the equipment into an outlet on a circuit different from that to which the receiver is connected.
- Consult the dealer or an experienced radio/television technician for help.

LIMITED 5 YEAR WARRANTY AND EXCLUSIONS

Leviton warrants to the original consumer purchaser and not for the benefit of anyone else that this product at the time of its sale by Leviton is free of defects in materials and workmanship under normal and proper use for five years from the purchase date. Leviton's only obligation is to correct such defects by repair or replacement, at its option, if within such five year period the product is returned prepaid, with proof of purchase date, and a description of the problem to **Leviton Manufacturing Co., Inc., Att: Quality Assurance Department, 59-25 Little Neck Parkway, Little Neck, New York 11362-2591**. This warranty excludes and there is disclaimed liability for labor for removal of this product or reinstallation. This warranty is void if this product is installed improperly or in an improper environment, overloaded, misused, opened, abused, or altered in any manner, or is not used under normal operating conditions or not in accordance with any labels or instructions. **There are no other or implied warranties of any kind, including merchantability and fitness for a particular purpose**, but if any implied warranty is required by the applicable jurisdiction, the duration of any such implied warranty, including merchantability and fitness for a particular purpose, is limited to five years. **Leviton is not liable for incidental, indirect, special, or consequential damages, including without limitation, damage to, or loss of use of, any equipment, lost sales or profits or delay or failure to perform this warranty obligation.** The remedies provided herein are the exclusive remedies under this warranty, whether based on contract, tort or otherwise. DI-000-VPH08-02A