



# 40W 12V DC LED Driver



E465183

## 40W Voltage Dimmable Class 2 LED Driver

Product Code: E40L12DC-KO

Magnitude's E40L12DC-KO dimmable voltage LED driver is class 2 rated and designed to operate with any standard MLV/Incandescent TRIAC (Leading edge) dimmer switch. Encased in a low profile aluminum enclosure that includes 2 knock-outs to enable easy installation makes it the perfect choice for under cabinet lights, tape lights and various LED fixtures installations. Our electrical specification includes Auto Reset, over current and short circuit protection. Efficiency of 90% and higher allows the driver to operate at low temperatures.

## Features

Dimmable with any standard MLV/Incandescent TRIAC- (Leading edge) dimmer switch

Super compact ALUMINUM CASE.

Class 2

UL 8750

IP67 - Withstands wet and salty conditions.

Auto-Reset Protection for short circuits, over-voltage and over-temperature.

FCC 15 part 2

12V DC True RMS

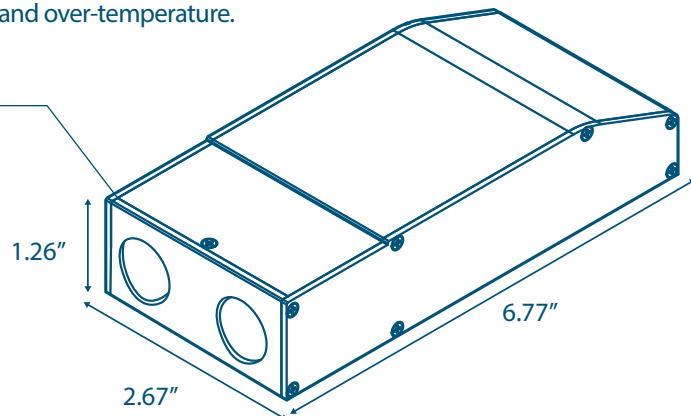
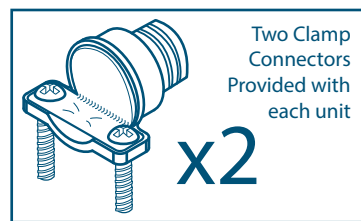
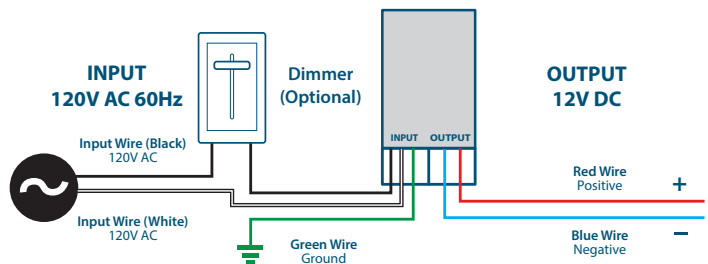

## Specifications

Max Load	40W
Input Voltage	120V AC
Input Current at Max Load	0.41 A
Output Voltage	12V DC
Output Current at Max Load	3.5 A
Power Factor	0.95
Efficiency	> 90%
Operating Temp.	-20°C - 70°C (-4°F - 158°F)
Short circuit protection	Yes
Overcurrent	Yes
Over temperature	Yes
Open circuit protection	Yes
Input Wires (White \ Black)	14 AWG
Output Wires (Red \ Black)	18 AWG
Dimensions L*W*H	6.77" x 2.67" x 1.26"
Weight	17 oz

— Output Voltage vs. Load

— Output Voltage With a Typical TRIAC Dimmer (on Max)

