

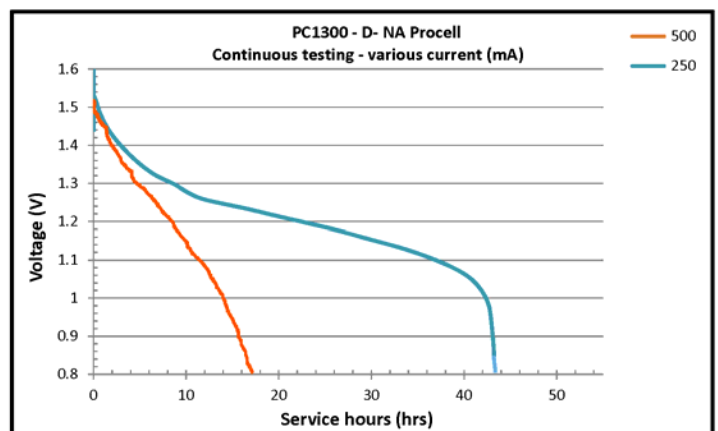

|                                    |   |
|------------------------------------|---|
| <b>Nominal voltage</b>             | 1.5 V                                       |
| <b>Impedance</b>                   | 136 m-ohm @ 1 kHz                           |
| <b>Typical weight</b>              | 139 g (4.9 oz)                              |
| <b>Typical volume</b>              | 56.4 cm <sup>3</sup> (3.4 in <sup>3</sup> ) |
| <b>Terminals</b>                   | Flat  |
| <b>Storage temperature range</b>   | 5°C to 30°C (41°F to 86°F)                  |
| <b>Operating temperature range</b> | -20°C to 54°C (-4°F to 130°F)               |
| <b>Designation</b>                 | IEC: LR20 ANSI: 13A                         |

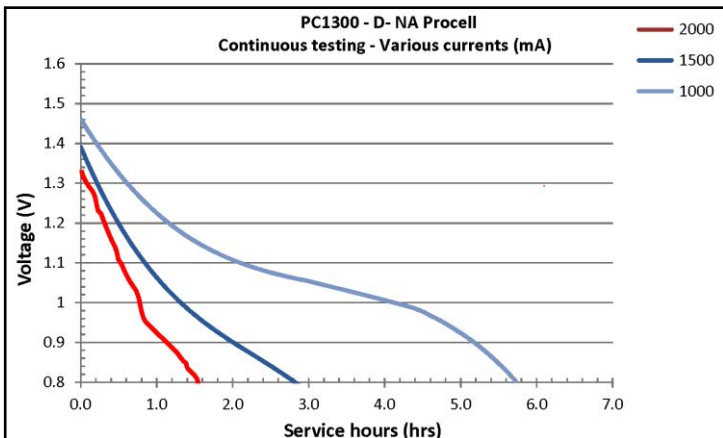
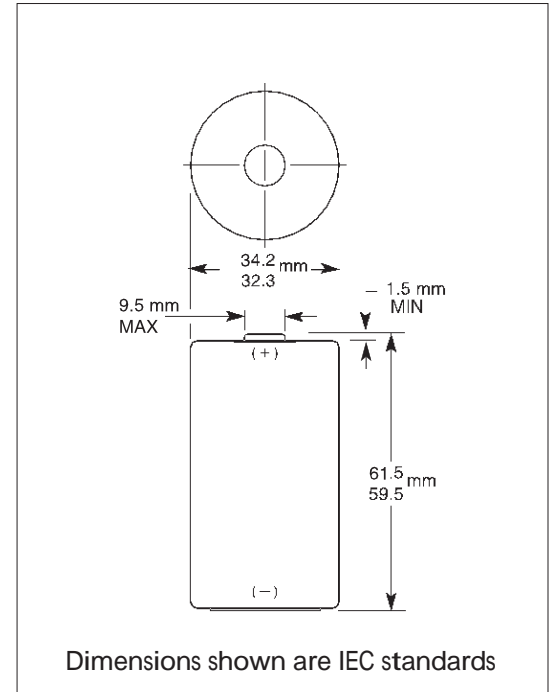

Berkshire Corporate Park  
Bethel, CT. 06801 U.S.A.  
Telephone: Toll-free 1-800-544-5454  
www.duracell.com

Delivered capacity is dependent on the applied load, operating temperature and cut-off voltage. Please refer to the charts and discharge data shown for examples of the energy/service life that the battery will provide for various load conditions.

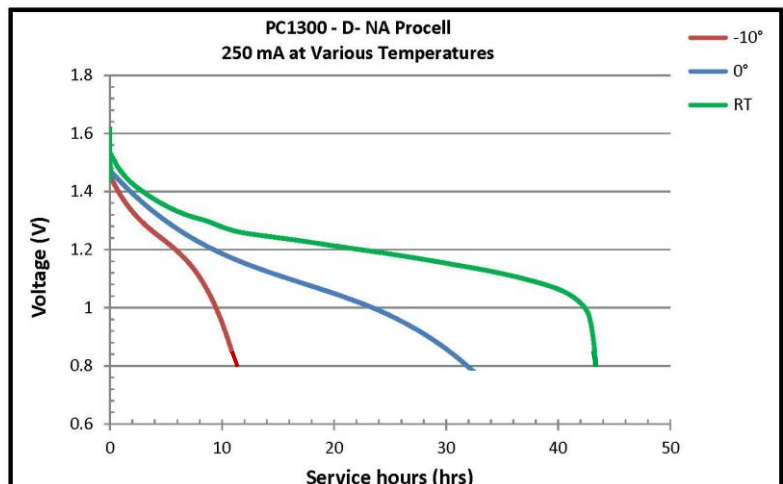
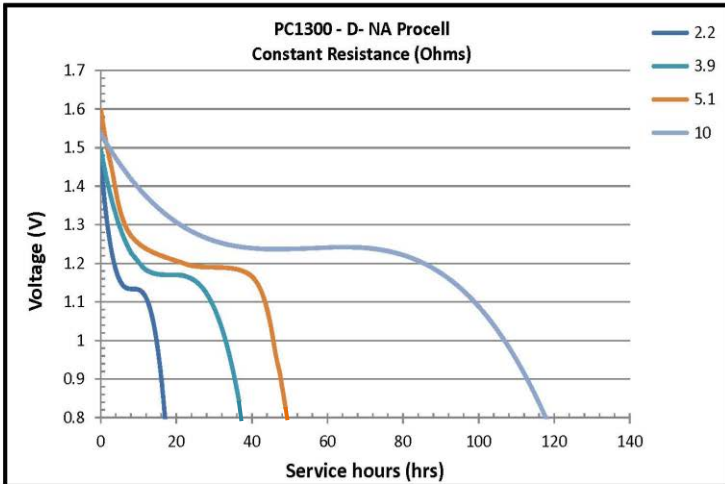
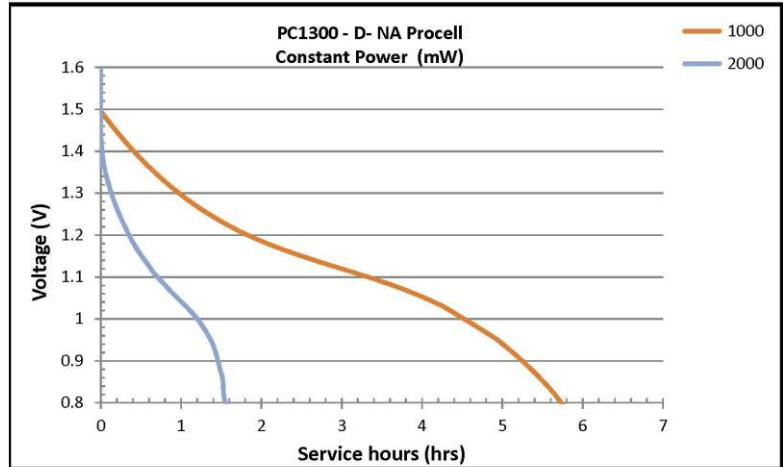
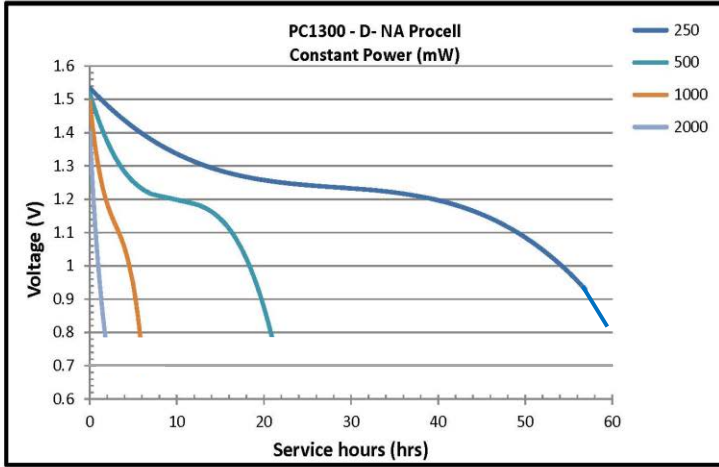

**DURACELL®**  
BATTERIES

Berkshire Corporate Park  
Bethel, CT. 06801 U.S.A.  
Telephone: Toll-free 1-800-544-5454  
www.duracell.com

Delivered capacity is dependent on the applied load, operating temperature and cut-off voltage. Please refer to the charts and discharge data shown for examples of the energy/service life that the battery will provide for various load conditions.