

Maestro® Occupancy Sensor C•L® Dimmer

Lutron® Maestro® occupancy sensor C•L® dimmers are lighting controls with passive infrared sensors that automatically control the lights in an area. These sensors detect heat from occupants moving within an area to determine when the space is occupied. The Maestro® occupancy sensor C•L® dimmer combines a Maestro® C•L® dimmer with an occupancy or vacancy sensor.

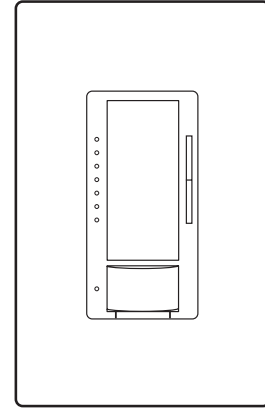

Features

- Controls CFL, LED, incandescent, and halogen load types*
- Passive infrared motion detection with exclusive Lutron® XCT™ Technology for fine motion detection
- 180° sensor field-of-view
- Up to 30 ft x 30 ft (9 m x 9 m) [900 ft² (81 m²)] major motion coverage and 20 ft x 20 ft (6 m x 6 m) [400 ft² (36 m²)] minor motion coverage
- Occupancy version can be set to auto-on/auto-off or manual-on/auto-off
- Vacancy version available to meet CA Title 24 requirements
- Adjustable timeout (1, 3, 5, 15, or 30 minutes) and high/low sensitivity adjustment
- Adjustable settings for auto-on light level (occupied level): 100%, 50%, last light level, or locked preset light level
- Off warning fades lights to off over a period of 10 seconds
- Advanced Maestro® dimmer features available (locked preset, fade-to-on, and fade-to-off, etc.)
- All models have single pole and multi-location capability
- Works with a single standard mechanical 3-way switch or up to 9 companion dimmers/switches (MA-R or MSC-AD)**

Models Available

Model Number***	Description	Sensor Operation	Maximum Capacity
MSCL-OP153M-XX	Occupancy/vacancy single-pole/multi-location	Auto-on/auto-off or manual-on/auto-off	600 W incandescent/halogen 150 W CFL/LED*
MSCL-VP153M-XX	Vacancy single-pole/multi-location	Manual-on/auto-off	600 W incandescent/halogen 150 W CFL/LED*

* For a complete list of compatible DIMMABLE CFLs and LEDs please visit www.lutron.com/dimcflled

** If using with standard mechanical 3-way switch, some rewiring and dimmer programming is required

*** XX in model number represents color/finish code

Job Name:	Model Numbers:
Job Number:	

Specifications

Regulatory Approvals

- UL Listed to U.S. and Canadian safety requirements
- Title 20/24 certified lighting control device
 - Complies with Title 20 and Title 24 Section 119 (Until Jan 1st, 2014)
- Title 20/24 certified lighting control device
 - Complies with Title 20 and Title 24 Section 110.9 (After Jan 1st, 2014)

Power

- Operating voltage: 120 V~ 60 Hz

Environment

- Ambient operating temperature: 32 °F to 104 °F (0 °C to 40 °C), 0%-90% humidity, non-condensing; indoor use only

Warranty

- 5 Year Limited Warranty

For additional Warranty information, please visit: www.lutron.com/TechnicalDocumentLibrary/Sensor_Warranty.pdf

Key Design Features

Dimmer

- On a single-tap, lights fade ON or OFF
- On a double-tap, lights go to full ON
- When ON, press and hold to engage a long fade to OFF
- Light levels can be fine-tuned by pressing and holding the dimming rocker until the desired light level is reached

Custom Sensor Settings

Timeout Options

- 1 Minute
- 3 Minute
- 5 Minutes (default)
- 15 Minutes
- 30 Minutes
- Test Mode
 - Short (less than 15-second) timeout for testing sensor coverage. After entering, device will exit test mode automatically after 5 minutes, or when any button is pressed.

Sensitivity Options

- High sensitivity (default)
- Low sensitivity

Auto-ON Options

- Occupancy (default): Auto-ON / Auto-OFF
 - Occupancy Mode is also called “Auto-On: Enabled”
- Vacancy*: Manual-ON / Auto-OFF
 - Vacancy Mode is also called “Auto-On: Disabled”

* There is a 15-second grace period that begins when the lights are automatically turned off, during which the lights will automatically turn back on in response to motion. This grace period is provided as a safety and convenience feature in the event that the lights turn off while the room is still occupied, so that the user does not need to manually turn the lights back on. After 15 seconds, the grace period expires and the lights must be manually turned on.

- Ambient Light Detection (ALD): Lights turn on only if natural light in room is low
 - Smart—Ambient light threshold adjusts to the user’s preference**

** If sensor turns on when there is enough natural light, or if sensor does not turn on when there is not enough natural light, press the large button within 5 seconds of entering the room. Over time, this interaction will “teach” the sensor your preferred setting.

- Off While Occupied (OWO)
 - When the sensor dimmer is manually turned off, the sensor dimmer will not turn the lights back on automatically while the room is occupied.
 - Once the room is vacated, the Auto-ON feature returns to normal operation after the timeout period has expired.
 - This may be the preference in conference rooms or classrooms while viewing presentations. This feature requires motion to keep the lights off.

Occupied Level Options

Occupied Level is the light level that the sensor dimmer will turn ON to when motion is detected.

- 100% (default)
- 50%
- Preset
 - While in preset mode, lights will automatically turn to the last level or to the “Locked Preset” level if a “Locked Preset” has been selected in Advanced Programming.

Job Name: Job Number:	Model Numbers:
--------------------------------------------	-----------------------

Load Type and Capacity

Control	Voltage	Load Type ¹	Minimum Load	Maximum Load			Neutral Connection Required
				Not Ganged	End of Gang	Middle of Gang	
MSCL-OP153M MSCL-VP153M	120 V~	Incandescent, halogen, CFL, LED ²	1 bulb, or as noted on approved bulb list ³	600 W incan/halogen or 150 W CFL/LED	500 W incan/halogen or 150 W CFL/LED	400 W incan/halogen or 150 W CFL/LED	NO

¹ Dimmer Load Type: designed for use with permanently installed lighting fixtures only. Do not install dimmers to control receptacles or motor-operated appliances.

² For mixed load types, see **Mixed Load Type and Capacity** section.

³ For a complete list of approved Dimmable CFLs and LEDs, please visit www.lutron.com/dimcflled. For questions call: 1.800.523.9466.

Mixed Load Type and Capacity

Determine allowable wattage (W) of dimmer by following the steps below. If multiple dimmers are to be installed adjacently in the same wallbox, derating is required.

Derating Chart

- Determine total wattage of CFL/LED bulbs installed for dimmer control.
- Determine total wattage of Incandescent/Halogen bulbs to be controlled by the dimmer.
- Use the Derating Chart to determine if your total wattages are within the allowable range of your configuration.
- Derating Procedure** (if necessary)
If multiple dimmers are installed adjacently in the same wallbox, heat fins MUST be removed between adjacent dimmers. This will permanently derate the dimmer, reducing its total allowable Incandescent/Halogen wattage.

Derating Chart

Placing dimmers adjacent to mechanical switches does not require derating.

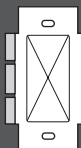

A

Two dimmers adjacent to each other.

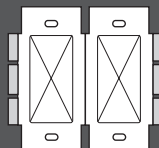

B B

Three dimmers adjacent to each other.

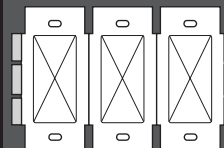

B C B

	Incandescent/Halogen : Total Wattage		
 Total W CFL/LED	A	B	C
0 W	10 W – 600 W	10 W – 500 W	10 W – 400 W
1 W – 25 W	0 W – 500 W	0 W – 400 W	0 W – 300 W
26 W – 50 W	0 W – 400 W	0 W – 300 W	0 W – 200 W
51 W – 75 W	0 W – 300 W	0 W – 200 W	0 W – 100 W
76 W – 100 W	0 W – 200 W	0 W – 100 W	0 W – 50 W
101 W – 125 W	0 W – 100 W	0 W – 50 W	0 W
126 W – 150 W	0 W	0 W	0 W

Example

If heat fins from one side of dimmer are removed (see **B** in chart) and you have two 24 W CFL bulbs installed (Total CFL Wattage = 48 W), you may add up to 300 W of Incandescent/Halogen lighting.

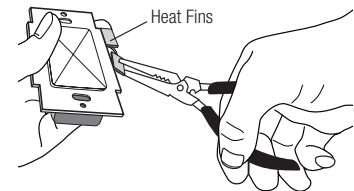

Additional Information

- For Maestro® Occupancy sensing switch models, please see Lutron® P/N 369666 at www.lutron.com.
- Lutron Technical Hotline: 1.800.523.9466.

Job Name:	Model Numbers:
Job Number:	

Maestro® Occupancy Sensor C•L® Dimmer Placement and Operation

- The ability of the sensor dimmer to detect motion requires line-of-sight of room occupants. The sensor dimmer must have an unobstructed view of the room.
- Hot objects and moving air currents can affect the performance of the sensor dimmer. For best performance, the sensor dimmer should be mounted at least 4 ft (1.2 m) away from HVAC vents and light bulbs.
- The performance of the sensor dimmer depends on a temperature differential between the ambient room temperature and that of room occupants. Warmer rooms may reduce the ability of the sensor dimmer to detect occupants.

NEMA WD7 Test Grid Coverage (High Sensitivity Setting)

-  Major motion coverage: 900 ft² (81 m²)
-  Minor motion coverage: 400 ft² (36 m²)

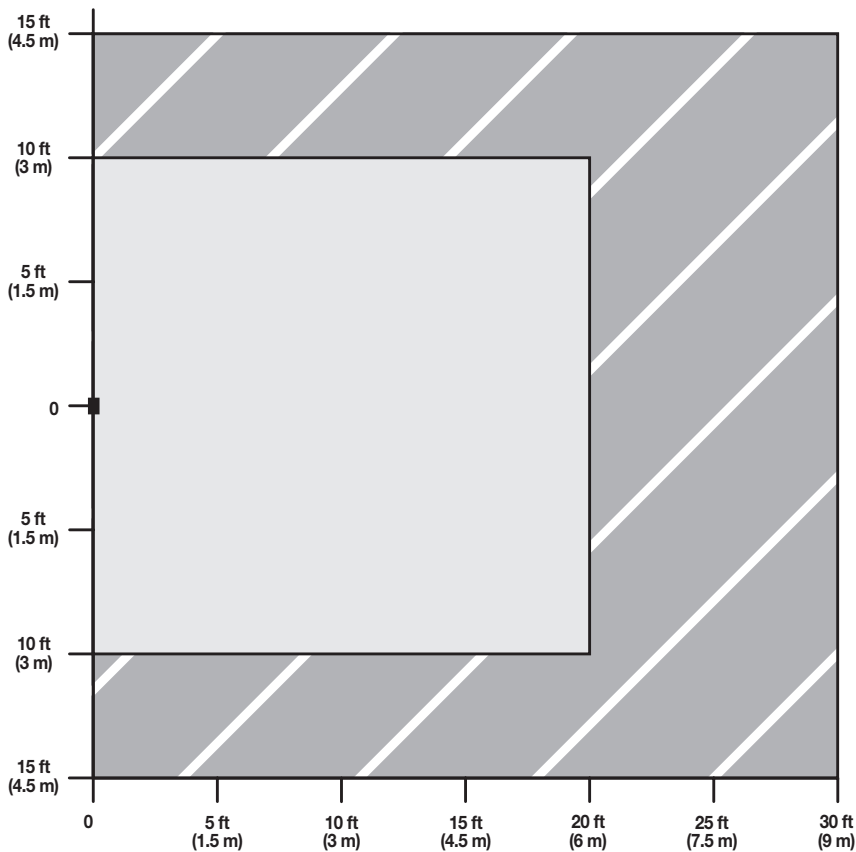

Horizontal Beam Diagram

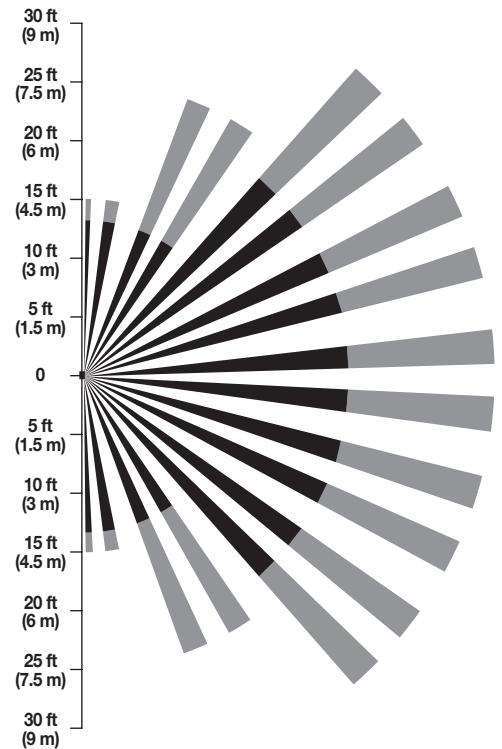

Vertical Beam Diagram

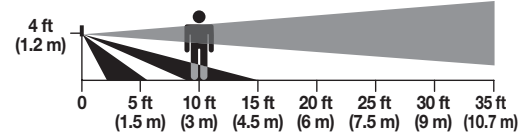

Job Name:	Model Numbers:
Job Number:	

Operation

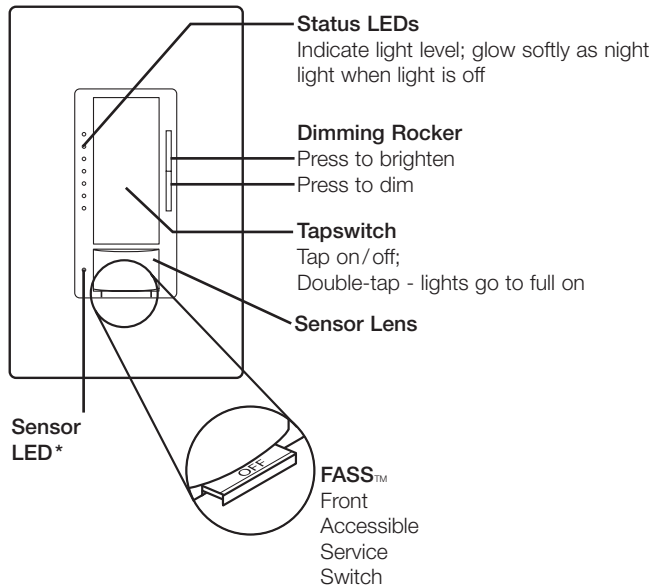

NOTE:

* LED only pulses to acknowledge motion when there is motion AND the load is ON.

IMPORTANT NOTICE:
FASS™ – Front Accessible Service Switch – to service load, remove power by pulling the FASS™ switch out completely on either the sensor dimmer or companion dimmer. After servicing load, push the FASS™ switch back in fully to restore power to the control. Once power has been restored, the sensing dimmer can be manually turned on or off but will not automatically control the load for the first 2 minutes.

Mounting

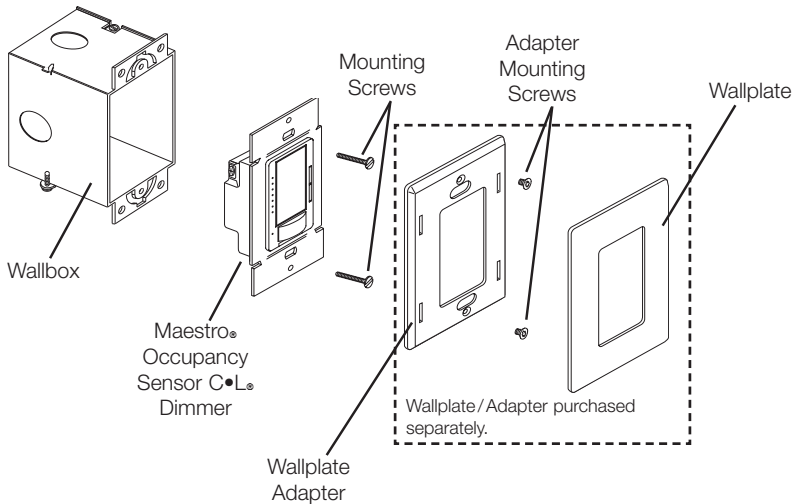

Job Name:	Model Numbers:
Job Number:	

Dimensions

Measurements shown as: in (mm)

Front View

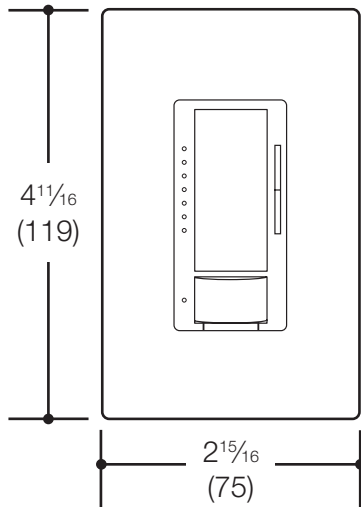

Side View

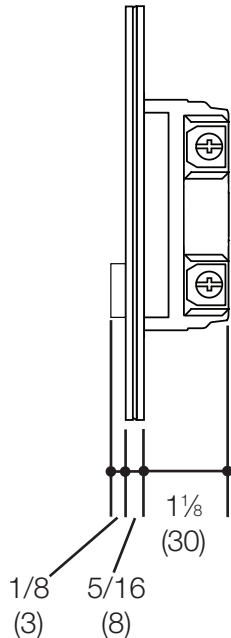

Note: MSCL-OP153M and MSCL-VP153M have screw terminals.

Job Name:	Model Numbers:
Job Number:	

Wiring Diagrams

Wiring Diagram 1

Single Location Installation¹

MSCL-OP153M and MSCL-VP153M

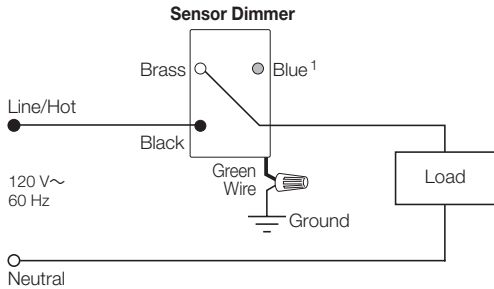

Wiring Diagram 2

Multi-Location Installation^{2, 3, 4}

MSCL-OP153M and MSCL-VP153M with MA-R or MSC-AD

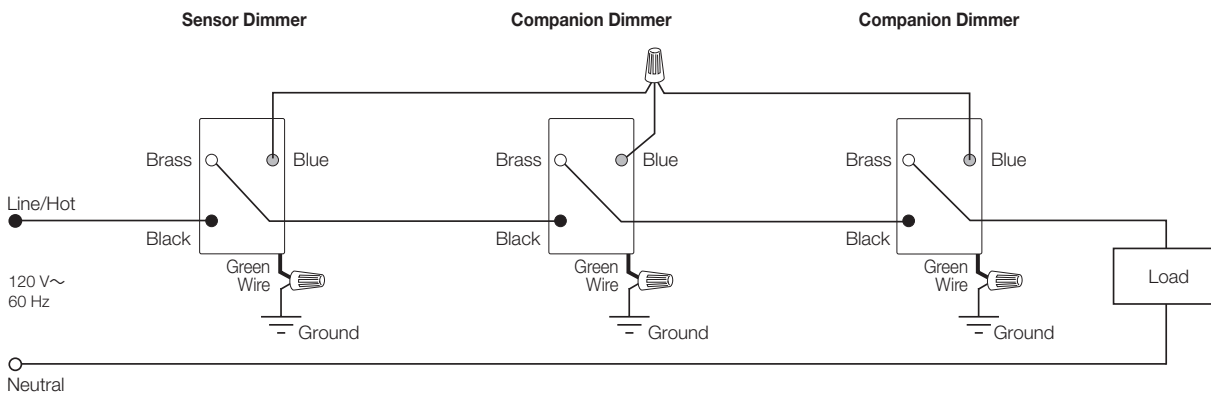

¹ When using controls in single location installations, tighten the blue terminal. **Do not** connect the blue terminal to any other wiring or to ground.

² Up to 9 companion dimmers may be connected to a sensor dimmer. Total blue terminal wire length may be up to 150 ft (46 m).

³ Only one sensor dimmer can be used per multi-location circuit.

⁴ Sensor dimmer can be installed in any location in the circuit.

Job Name:	Model Numbers:
Job Number:	

Wiring Diagrams *(continued)*

Wiring Diagram 3

3-way Installation with Standard Mechanical Switch (120 V~)^{1, 2}

MSCL-OP153M and MSCL-VP153M

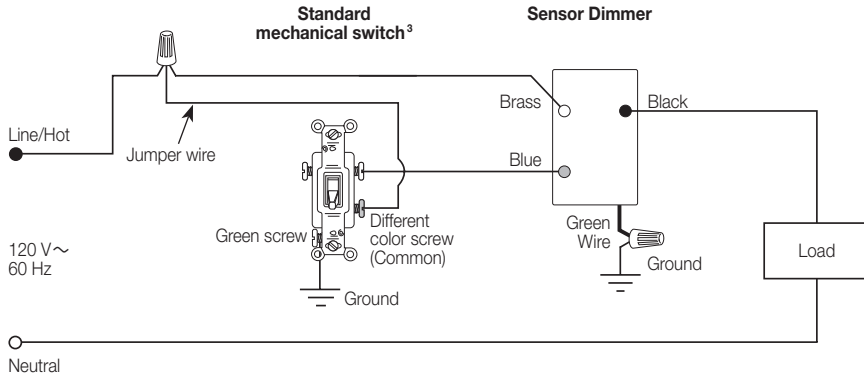

OR

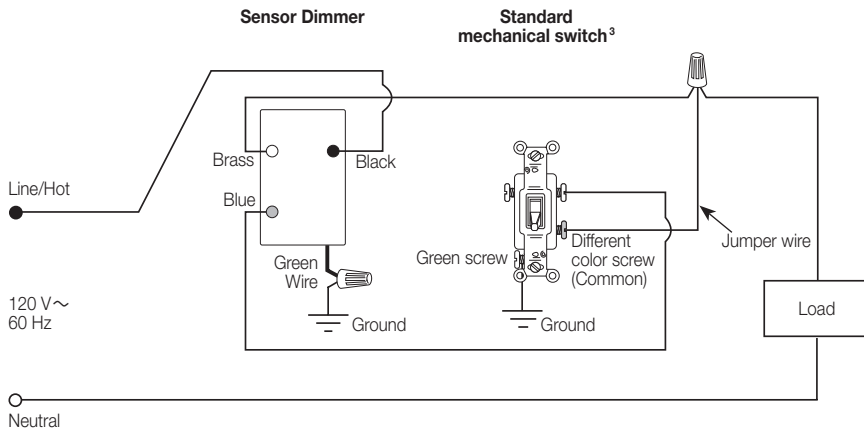

¹ Only one sensor dimmer can be used per multi-location circuit.

² A single standard mechanical 3-way switch or up to 9 companion dimmers may be connected to a sensor dimmer. Standard mechanical 3-way switch cannot be combined with companion dimmer. Total blue terminal wire length may be up to 150 ft (46 m).

³ Diagram 3 shows a typical retrofit scenario, where one mechanical 3-way switch is being replaced with a sensor dimmer. The remaining mechanical 3-way switch needs to be modified to effectively convert it to a single pole switch. For new construction, a standard mechanical single pole switch can be used here.

Job Name:	Model Numbers:
Job Number:	

Colors and Finishes

Gloss Finishes

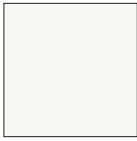

White
WH



Ivory
IV

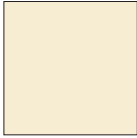

Almond
AL



Light
Almond
LA



Gray
GR

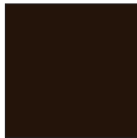

Brown
BR



Black
BL

Satin Finishes



Hot
HT



Merlot
MR



Plum
PL



Turquoise
TQ



Taupe
TP



Eggshell
ES



Biscuit
BI



Snow
SW



Palladium
PD



Midnight
MN



Sienna
SI

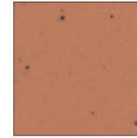

Terracotta
TC



Greenbriar
GB



Bluestone
BG

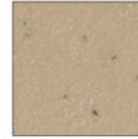

Mocha
Stone
MS

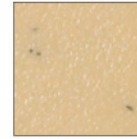

Goldstone
GS



Desert Stone
DS

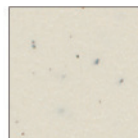

Stone
ST



Limestone
LS



Sea Glass
SG

Due to printing limitations, colors and finishes shown cannot be guaranteed to perfectly match actual product colors.

Job Name: Job Number:	Model Numbers:
--------------------------------------------	-----------------------