

Maestro® Wireless Plug-In Appliance Module

The plug-in appliance module is an easy-to-install RF control for use with general purpose switching loads. Communication with the *Maestro Wireless* system is accomplished by using Clear Connect™ RF technology. The appliance module can be configured to work with Pico® wireless controls and Radio Powr Savr™ sensors to turn off lighting and loads in standby mode such as printers, monitors, and televisions when the space is unoccupied.

Features

- Softswitch®: Lutron's patented technology prevents the relay contacts from arcing, extending the switch's average life.
- The plug-in appliance module can be controlled using a *Pico* wireless control and a *Radio Powr Savr* occupancy/vacancy sensor.
- Over-temperature detection: The unit will turn off if it detects a mis-application due to an excessive ambient temperature or overload.
- Typical power consumption: 0.3 W (typical test conditions = load off).
- Can be hidden discretely behind furniture.

The appliance module may be used with, but is not limited to, the following:

- Task lighting
- Monitors
- Printers
- Fans
- Televisions
- Powered speakers
- Audio equipment
- Receivers

Refer to the manufacturer's guidelines for acceptable switching methods for devices used with the appliance module.

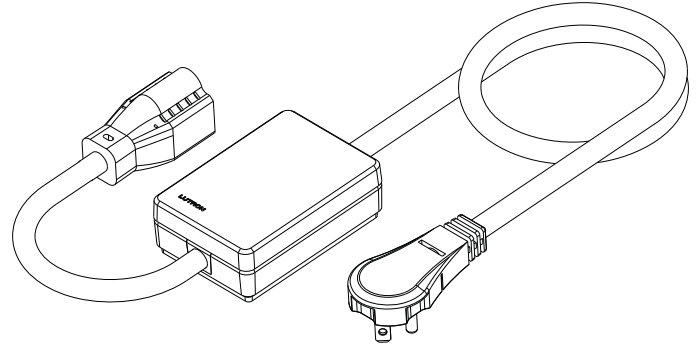

MRF2-15APS-1-XX (1 receptacle)

XX = indicates color choice

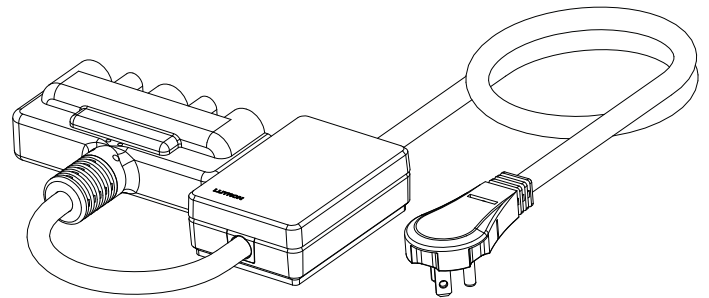

MRF2-15APS-3-XX (3 receptacles)

XX = indicates color choice

The appliance module may not be suitable for use with devices that require any of the following:

- Shut-down process before power is interrupted, such as computers
- Cool-down process before power is interrupted, such as projectors
- Programming, such as clocks or DVRs
- Long warm-up cycle

| | |
|-------------|----------------|
| Job Name: | Model Numbers: |
| Job Number: | |

Specifications

Standards

- UL Listed.
- FCC approved. Complies with the limits for a Class B digital device, pursuant to Part 15 of the FCC rules.
- cUL certified, IC approved.
- NOM certified, SCT approved in Q4 2010.

Power / Performance

- Operating voltage: 120 V~ 50/60 Hz
- Typical power consumption: 0.3 W (typical test conditions = load off).

System Communication

- Communicates at 434 MHz through Clear Connect™ RF Technology for reliable wireless communication.

Environment

- Ambient operating temperature: 32 – 104 °F (0 – 40 °C)
- Maximum 90% non-condensing relative humidity
- Indoor use only

Available Colors

- White (WH)
- Black (BL)

Load

- Maximum load: 15 A general purpose. No minimum load requirements. *
- Motor rating: ½ HP
- Lutron's patented Softswitch® technology extends the switch's average life.

* Some low wattage loads may try to start when the Appliance Module is "OFF" due to a 0.5 mA leakage current through the module in "OFF" state, similar to a night lighted toggle switch. Consult the manufacturer of the load for compatibility.

Key Design Features

- Green LED status indicator shows current load status.
- Power failure memory: If power is interrupted, when the power is restored the appliance module will return to its previously set level prior to the interruption.

Design Considerations

- When switching lamps with integral switches, the integral switch must be left in the "on" position or removed from the lamp. Always use a bulb that remains within the manufacturer's wattage rating of the table or floor lamp.

System Communication and Capacity

- *Maestro* Wireless RF appliance module communicates with ceiling-mount occupancy sensors and Pico® wireless controls through radio frequency (RF).
- *Maestro* Wireless local controls must be located within 60 ft (18 m) line of sight or 30 ft (9 m) through walls of a Radio Powr Savr™ Sensor.
- Up to 10 *Maestro* Wireless controls can be configured to work together.

Over-Temperature Detection

- If an over-temperature condition is detected, the LED on the unit will flash a unique sequence (double-blink, then pause) and turn the load off. Proper installation and conformance to all specifications should be ensured before proceeding. To return the device to normal operation, simply cycle power to the device.

| | |
|--|-----------------------|
| Job Name: Job Number: | Model Numbers: |
|--|-----------------------|

Mechanical Dimensions

Dimensions are for reference only.

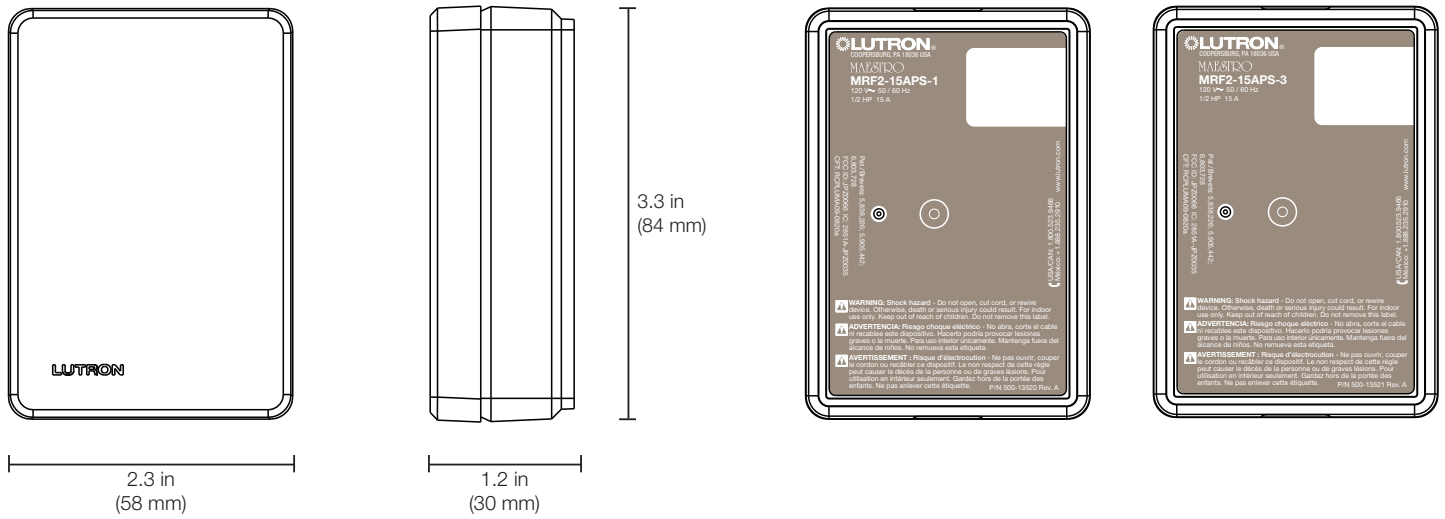

Plug Details

- Male plug on 24 in (610 mm) cord
- Female receptacle on 6 in (150 mm) cord

Male Plug

Both models

Side View

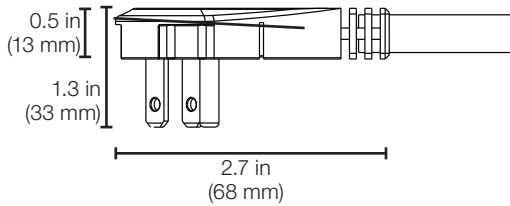

Bottom view

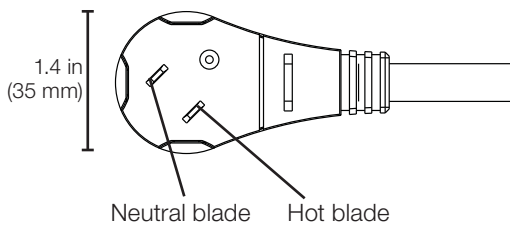

Female Plug

MRF2-15APS-1

Side Views

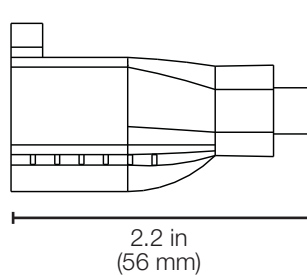
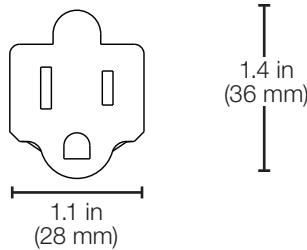

Female Plug

MRF2-15APS-3

Side Views

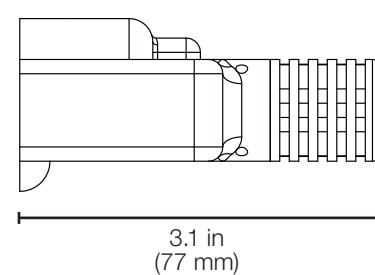
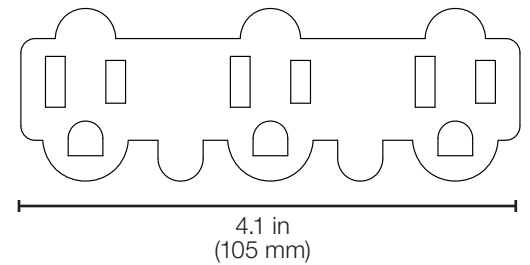

| | |
|--|-----------------------|
| <p>Job Name:</p> <p>Job Number:</p> | <p>Model Numbers:</p> |
|--|-----------------------|