



PAR30

Dimmable Recessed Light

100W halogen equivalent

Features

- Innovative anti-glare lens technology
- Energy Star certified (3000K)
- Available in a variety of CCTs and beam angles
- Special high CRI models
- Top performing light output and efficacy
- High Power Factor
- Compatible with most ANSI/NEMA approved dimmers designed for LED use
- UL certified
- Comprehensive five-year warranty
- Tested per IESNA LM-79-2008



Leapfrog Lighting's ENERGY STAR certified PAR30 LED lamp provides industry-leading light quality, output power, and efficacy as a result of our patented intelligent optics lens and high-efficiency, high-reliability LED source and driver electronics.

LIGHT QUALITY

Evenly distributed, glare-free light with gentle roll-off at edges

APPLICATIONS

Indoor and unexposed outdoor down-lighting applications

LIFE EXPECTANCY

40,000 hours
ENERGY STAR rated models: 25,000 hours based on preliminary testing

PERFORMANCE

Dimmable, high efficacy (lm/W), single light source

COLOR

Ultra-consistent color temperature control critical to multi-lamp applications, with high CRI and pleasing CCT options.

WATTAGE EQUIVALENCY

100 Watt halogen equivalent

SPECIFICATIONS

CCT ¹	CRI ²	BEAM	LM	W	LM/W	PART
2700K	82	20°	1035	13	80	1002-P30LC-2703
	82	38°	1035	13	80	1002-P30LC-2701
	82	60°	1035	13	80	1002-P30LC-2702
	95	20°	860	13	66	1002-P30LC-2706
	95	38°	860	13	66	1002-P30LC-2704
3000K	80	20°	1055	13	81	1002-P30LC-3003
	80	38°	1055	13	81	1002-P30LC-3001
	80	60°	1055	13	81	1002-P30LC-3002
	95	20°	876	13	67	1002-P30LC-3006
	95	38°	876	13	67	1002-P30LC-3004
5000K	82	20°	1100	13	85	1002-P30LC-5003
	82	38°	1100	13	85	1002-P30LC-5001
	82	60°	1100	13	85	1002-P30LC-5002
	95	20°	913	13	70	1002-P30LC-5006
	95	38°	913	13	70	1002-P30LC-5004
95	60°	913	13	70	1002-P30LC-5005	

1. Tolerances as per ANSI C78.377-2008 Nominal CCT categories
2. CRI refers to the "General CRI" described as Ra in CIE 13.3

GENERAL

Min. lifetime ³	40,000 hours
Base type	E26/E27
Weight	10.4 oz.
Dimensions ⁴	PAR30L

ELECTRICAL

Voltage, nominal	120 VAC
Power factor	> 0.95
Dimming range	Flicker free down to 10% light output

OPTICAL

Duv ⁵	< 0.006
------------------	---------

3. Lifetime as defined by IESNA LM-80
4. Compatible with ANSI C78.21-2011 dimensional requirements
5. Duv values and tolerances as per ANSI C78.377-2008 Nominal CCT, Table 1, page 8

BASE TYPE

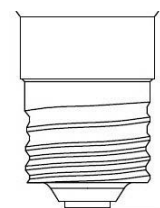

E26/27

PAR30 DIMMER COMPATIBILITY (North America)

MANUFACTURER	BRAND	MODEL	NUMBER OF LAMPS / DIMMER										
			1	2	3	4	5	6	7	8	9	10	
Lutron	Skylark	s-600P-WH	OK	OK	OK	OK	OK	OK	OK	OK	OK	OK	OK
	Maestro	MS-OP600GHW-WH	-	-	OK	OK	-	-	OK	OK	OK	OK	
	Toggler	TGCL-153PH-WH	OK	OK	OK	OK	OK	OK	OK	OK	OK	OK	
Leviton	Decora	IPI106	OK	OK	OK	OK	OK	OK	OK	OK	OK	OK	
	SURESLIDE	6633-P	OK	OK	OK	OK	OK	OK	OK	OK	OK	OK	
Panasonic	Panasonic	WN576280K	OK	OK	OK	OK	OK	OK	OK	OK	OK	OK	
Incandescent	Slide dimmer	DMS-SIL	OK	OK	OK	OK	OK	OK	OK	OK	OK	OK	

POLAR INTENSITY DIAGRAMS

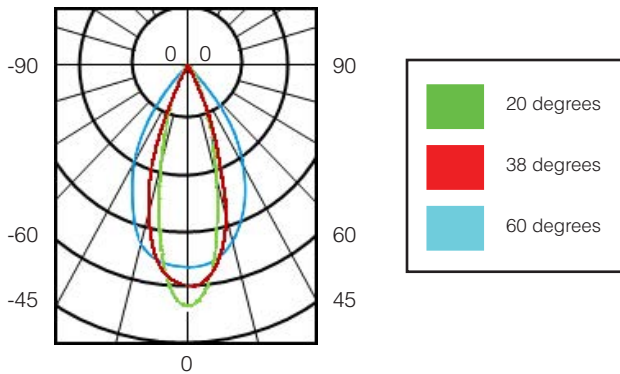

DIMENSIONS

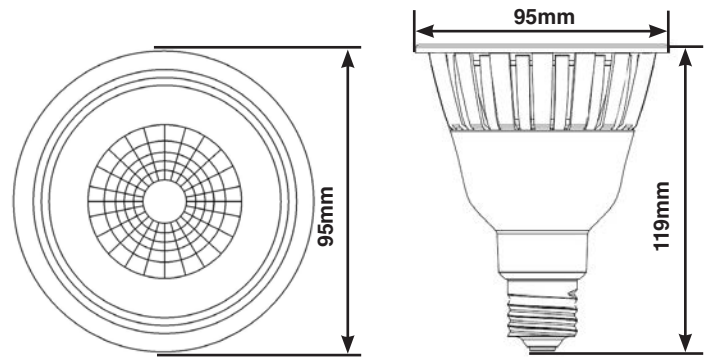

SPECTRAL POWER DISTRIBUTION

2700K

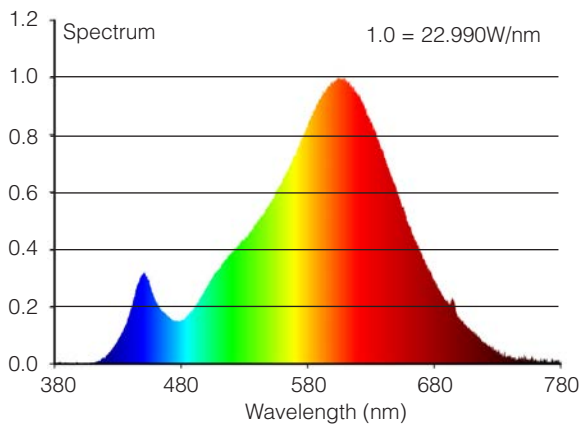

3000K

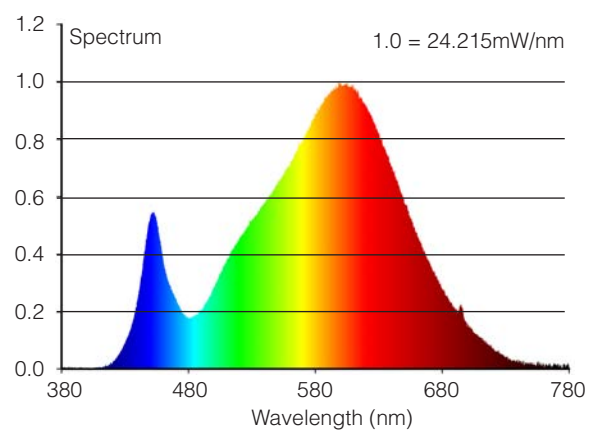

5000K

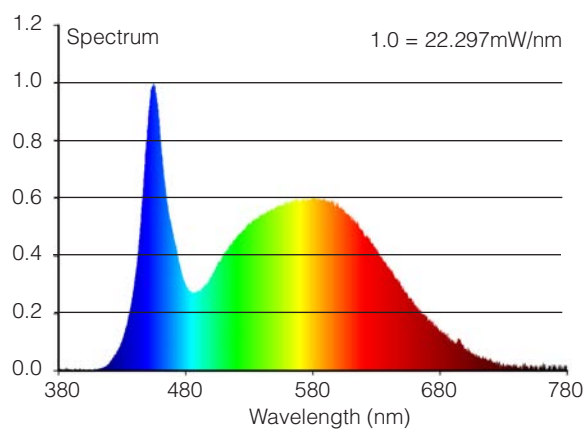

BEAM ANGLES

20 degrees

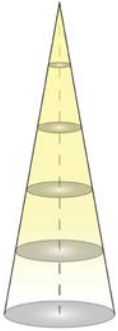

DISTANCE (m)	AVG./MAX. E (lux)			DIAMETER (m)
	2700K	3000K	4000K / 5000K	
1	3909 / 5426	4188 / 5814	4502 / 6250	0.33
2	977 / 1357	1047 / 1454	1126 / 1563	0.66
3	434 / 603	465 / 646	500 / 694	0.99
4	244 / 339	262 / 363	281 / 391	1.32
5	156 / 217	168 / 233	180 / 250	1.66

38 degrees

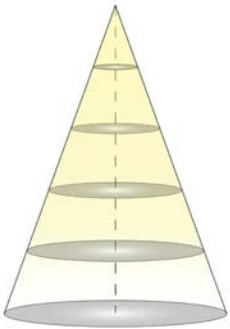

DISTANCE (m)	AVG./MAX. E (lux)			DIAMETER (m)
	2700K	3000K	4000K / 5000K	
1	1798 / 2518	1927 / 2698	2071 / 2900	0.60
2	450 / 630	482 / 675	518 / 725	1.21
3	200 / 280	214 / 300	230 / 322	1.81
4	112 / 157	120 / 169	129 / 181	2.42
5	72 / 101	77 / 108	83 / 116	3.02

60 degrees

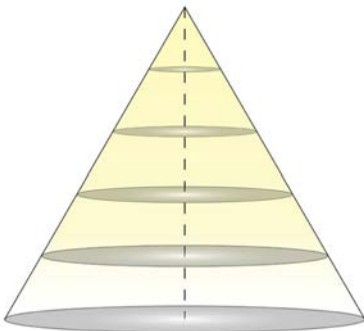

DISTANCE (m)	AVG./MAX. E (lux)			DIAMETER (m)
	2700K	3000K	4000K / 5000K	
1	751 / 1266	804 / 1356	865 / 1458	0.60
2	188 / 317	201 / 339	216 / 365	1.21
3	83 / 141	89 / 151	96 / 162	1.81
4	47 / 79	50 / 85	54 / 91	2.42
5	30 / 51	32 / 54	35 / 58	3.02

WARRANTY

If the lamp fails to meet our specifications during the first 60 months, we'll replace it.

For additional warranty information, please refer to <http://www.leapfroglighting.com/resources/>.

APPLICATION NOTES

Not for use in exposed outdoor down-lighting applications

Ambient temperature within -20 to +45 °C

SAFETY NOTES

Warning: Risk of electric shock

Do not disassemble (no user serviceable parts)

Turn off power before inspection, installation or removal.