

## LIMITED WARRANTY

**IDEAL AIR ONE-YEAR LIMITED WARRANTY.** IDEAL AIR PORTABLE AIR CONDITIONERS, MODELS COVERED IN THIS MANUAL, ARE WARRANTED BY IDEAL AIR TO THE ORIGINAL USER AGAINST DEFECTS IN WORKMANSHIP OR MATERIALS UNDER NORMAL USE FOR ONE YEAR AFTER DATE OF PURCHASE. ANY PART WHICH IS DETERMINED TO BE DEFECTIVE IN MATERIAL OR WORKMANSHIP AND RETURNED TO AN AUTHORIZED SERVICE LOCATION, IDEAL AIR DESIGNATES, SHIPPING COSTS PREPAID, WILL BE, AS THE EXCLUSIVE REMEDY, REPAIRED OR REPLACED BY IDEAL AIR'S OPTION. FOR LIMITED WARRANTY CLAIM PROCEDURES, SEE "PROMPT DISPOSITION" BELOW. THIS LIMITED WARRANTY GIVE PURCHASERS SPECIFIC LEGAL RIGHTS WHICH VARY FROM JURISDICTION TO JURISDICTION.

**LIMITATION OF LIABILITY.** TO THE EXTENT ALLOWABLE UNDER APPLICABLE LAW, IDEAL AIR'S LIABILITY FOR CONSEQUENTIAL AND INCIDENTAL DAMAGES IS EXPRESSLY DISCLAIMED. IDEAL AIR'S LIABILITY IN ALL EVENTS IS LIMITED TO AND SHALL NOT EXCEED THE PURCHASE PRICE PAID.

**WARRANTY DISCLAIMER.** A DILIGENT EFFORT HAS BEEN MADE TO PROVIDE PRODUCT INFORMATION AND ILLUSTRATE THE PRODUCTS IN THIS LITERATURE ACCURATELY; HOWEVER, SUCH INFORMATION AND ILLUSTRATIONS ARE FOR THE SOLE PURPOSE OF IDENTIFICATION, AND DO NOT EXPRESS OR IMPLY A WARRANTY THAT THE PRODUCTS ARE MERCHANTABILITY, OR FIT FOR PARTICULAR PURPOSE, OR THAT THE PRODUCTS WILL NECESSARILY CONFORM TO THE ILLUSTRATIONS OR DESCRIPTIONS, EXCEPT AS PROVIDED BELOW, NO WARRANTY OF AFFIRMATION OF FACT, EXPRESSED OR IMPLIED, OTHER THAN AS STATED IN THE "LIMITED WARRANTY" ABOVE IS MADE OR AUTHORIZED BY IDEAL AIR.

**Technical Advice and Recommendations, Disclaimer.** Notwithstanding any past practice or dealings or trade custom, sales shall not include the furnishing of technical advice or assistance or system design. Ideal Air assumes no obligations or liability on account of any unauthorized recommendations, opinions or advice as to the choice, installation or use of products.

**Product Suitability.** Many jurisdictions have codes and regulations governing sales, construction, installation, and/or use of products for certain purposes, which may vary from those in neighboring areas. While attempts are made to assure that Ideal Air products comply with such codes, Ideal Air cannot guarantee compliance, and cannot be responsible for how the product is installed or used. Before purchase and use of a product, review the product applications, and all applicable national and local codes and regulations, and be sure that the product, installation, and use will comply with them.

Certain aspects of disclaimers are not applicable to consumer products; e.g., (a) some jurisdictions do not allow the exclusion or limitation of incidental or consequential damages, so the above limitation or exclusion may not apply to you; (b) also, some jurisdictions do not allow a limitation on how long an implied warranty lasts, consequently the above limitation may not apply to you; and (c) by law, during the period of this Limited Warranty, any implied warranties of implied merchantability or fitness for a particular purpose applicable to consumer products purchased by consumers, may not be excluded or otherwise disclaimed.

**Prompt Disposition.** A good faith effort will be made for prompt correction or other adjustment with the respect to any product which proves to be defective within limited warranty. For any product believed to be defective within limited warranty, first write or call dealer from whom the product was purchased. Dealer will give additional directions. If unable to resolve satisfactorily, write to Ideal Air at the address below, giving dealer's name, address, date, and number of dealer's invoice, and describing the nature of the defect. Title and risk of loss pass to buyer on delivery to common carrier. If product was damaged in transit to you, file claim with carrier.

Manufactured for Ideal Air, 5408 N.E. 88th St., Bldg A, Vancouver, WA 98665 U.S.A

# IDEALair™ Portable Air Conditioners

## Description

Ideal Air™ Portable Air Conditioners feature spot cooling for large areas where cooling of the entire area is not practical. A dedicated spot cooling thermostat controls the unit in this application. These air conditioners can also be used in smaller areas for room cooling. A control panel provides ease of use and contains a self-diagnostic function and display, showing operating modes, room and set temperatures, and faults. If an abnormal operation occurs, a visual display of the fault is shown. Caster wheels are included for easy portability. Suitable applications include: a factory or work place, industrial kitchen, computer room, emergency cooling, outdoor event, etc.



700870 700875 700877  
Figure 1

## Unpacking

After unpacking the unit, carefully inspect unit for any damage that may have occurred during transit. Check for any loose, missing, or damaged parts.

## Specifications

### RATING

Model No.	Power Supply Ph-V/Hz	Capacity Btu/h	Power Consumption Watts	Rated Current Amps	EER Btu/Wh	Condensate Tank Gallons(Liters)	No. of Cool Air Outlets
700870	Single Phase, 115V, 60Hz	12,000	1400	11.5	8.6	3.17(12)	1
700875	Single Phase, 208 / 230V, 60Hz	21,000	2300	10.0	8.9	3.17(12)	2
700877	Single Phase, 208 / 230V, 60Hz	29,000	3100	14.0	9.3	3.17(12)	3

### APPLICATION

Model No.	Operation Temp. °F (°C)	Ambient Temp. °F (°C)	Application Area ft²(m²)	Dimensions W x H x D - in. (mm)	Net / Gross Wt.
700870	64 – 113 (18 – 45)	64 – 113 (18 – 45)	355 (33)	17.5 x 43.3 x 19.9 (445 x 1100 x 505)	132 / 145.5 lbs. (60 / 66 kg)
700875	64 – 113 (18 – 45)	64 – 113 (18 – 45)	527 (49)	22.0 x 50.4 x 24.4 (560 x 1280 x 620)	198 / 216 lbs. (90 / 98 kg)
700877	64 – 113 (18 – 45)	64 – 113 (18 – 45)	743 (69)	22.0 x 50.4 x 24.4 (560 x 1280 x 620)	209 / 227 lbs. (95 / 103 kg)

## Specifications (Continued)

### SYSTEM INFO

Model No.	Refrigerant Type / (oz.)	Design Pressure – Hi/Lo (Psig)	Indoor Air Flow – Hi/Lo ft <sup>3</sup> /min (m <sup>3</sup> /h)
700870	R410A / 15.9	450 / 250	283 / 247 (480 / 420)
700875	R410A / 42.3	450 / 250	512 / 477 (870 / 810)
700877	R410A / 39.9	450 / 280	583 / 547 (990 / 930)

### COMPRESSOR

Model No.	Type	Brand	Capacity Watts	Input Watts	Rated Current Amps	Locked Rotor Amps	Thermal Protecior	Capacitor	Refrigerant Oil (cc)
700870	Rotary	Toshiba	3460 ±5%	1175 ±5%	10.80 ±5%	47.3 + 10%	B480-135-141E	45uF / 250 v	350
700875	Rotary	Toshiba	5810 / 5900	2000 / 1980	9.7 / 8.7	34.8	—	50uF / 370 v	750
700877	Rotary	Toshiba	8160 / 8240 ±5%	2700 / 2715 ±5%	13 / 12 ±5%	60	—	50uF / 370 v	950

### FAN MOTOR 1

Model No.	Input Watts	Capacitor	Speed (Hi/Lo) - RPM
700870	91 / 89	10uF / 450v	1300 / 1150
700875	240 / 200	8uF / 450v	1300 / 1150
700877	240 / 200	5uF / 450v	1070 / 970

### FAN MOTOR 2

Model No.	Input Watts	Capacitor	Speed (Hi/Lo) - RPM
700870	81	3.5uF / 450v	1500
700875	255	8uF / 450v	1500
700877	242	7uF / 450v	1500

### EVAPORATOR

Model No.	Number of Rows	Tube Pitch x Row Pitch (mm)	Fin Spacing (mm)	Fin Type	Tube Outside Dia. and Type (mm)	Coil Length x Height x Width (mm)	Number of Circuits
700870	2	19 x 12.5	1.6	Aluminum	Φ7 x 0.28	260 x 350 x 25	2
700875	2	25.4 x 22	2.0	Aluminum	Φ9.52 x 0.34	450 x 393 x 44	2
700877	3	25.4 x 22	2.0	Aluminum	Φ9.52 x 0.34	450 x 393 x 66	3

### CONDENSER

Model No.	Number of Row	Tube Pitch x Row Pitch (mm)	Fin Spacing (mm)	Fin Type	Tube Outside Dia. and Type (mm)	Coil Length x Height x Width (mm)	Number of Circuits
700870	3	19 x 12.5	1.6	Aluminum	Φ7 x 0.28	300 x 445 x 38	2
700875	3	25.4 x 22	2.5	Aluminum	Φ9.52 x 0.34	460 x 560 x 81	2
700877	4	25.4 x 22	3.0	Aluminum	Φ9.52 x 0.34	460 x 560 x 100	2

Model No.	NEMA Plug Type / Molded Type	Cord Length	No.	Wheels Diameter
700870	5-20p	6 ft	4	76
700875	6-15p	6 ft	4	102
700877	6-20p	6 ft	4	102

## General Safety Information

Please read this manual carefully for instructions on correct installation and usage. Please read all safeguards.

1. Transport and store the unit in an upright position only. Leave unit in an upright position for at least 3 hours before first use.
2. Always place the unit on an even, level surface.
3. Ensure the unit is connected to a grounded power supply of the correct rating / capacity.
4. The unit will cool when the room temperature is between 18°C (64.4°F) ~ 45°C (113°F) depending on the thermostat setting.
5. DO NOT use this unit for functions other than those described in this instruction manual.
6. DO NOT tilt the unit.
7. DO NOT cover or obstruct the unit's inlet and outlet grilles.
8. DO NOT use the unit in areas where it will be exposed to rain or water.
9. NEVER unplug the unit while it is operating.

**▲ WARNING** *DO NOT use the unit in wet environments, such as a laundry room, to avoid the risk of electrical shock.*

10. DO NOT place any foreign objects on the unit.
11. DO NOT operate the unit with wet or damp hands.
12. DO NOT allow chemical substances to come into contact with the unit.
13. DO NOT operate the unit in the presence of flammable substances or vapors such as alcohols, pesticides, gasoline, etc.

**▲ WARNING** *DO NOT operate the unit in explosive or flammable environments.*

14. DO NOT use the plug to start and to stop the unit. Always use the control panel to start and to stop the unit.
15. Always turn off the unit when it is not in use and unplug the power plug from the electrical outlet.
16. Always turn the unit off and unplug the main power plug from the electrical outlet before cleaning, moving or performing maintenance.
17. AVOID the use of adapter plugs or extension cords. If it is necessary to use an extension cord or an adapter plug to operate the unit, ensure that they are correctly rated for the application. Consult a local qualified electrician and all local electrical codes to ensure proper setup. Any extension cord used with this device must be rated for a minimum of 15A.
18. DO NOT unplug the unit by pulling on the electrical cord. Keep electrical cord away from heat sources and always completely unroll the cord to avoid overheating. If the power cord becomes damaged, a qualified service agent, qualified electrician, or similarly qualified person must replace it, in order to avoid a hazard or shock.

**▲ WARNING** *DO NOT operate a unit with a damaged power cord.*

19. The filters must be used with the product at all times. When the filters are removed for cleaning, always ensure that the unit has been turned off and unplugged from the electrical outlet.
20. Regularly clean the filters to maintain efficiency. If the filters are not cleaned regularly, the units output performance and efficiency will decline and energy consumption will increase.
21. DO NOT operate the unit with a damaged power cord or plug, after it malfunctions, has been dropped or damaged.
22. Only use in the upright position on an even, flat surface. Unit must be positioned at least 24 inches (60 cm) from the nearest object in any direction.
23. Stop operation immediately if abnormal noise or odor is noticed. Contact a local service center.

**SAVE THESE INSTRUCTIONS**

## Assembly

### COMPONENT PARTS

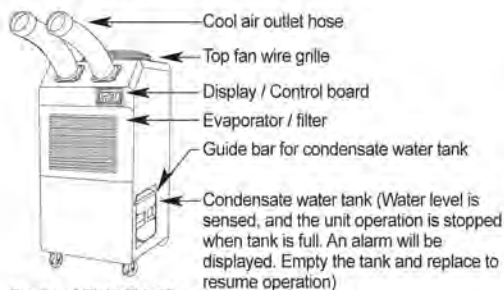

Front and Right Side View

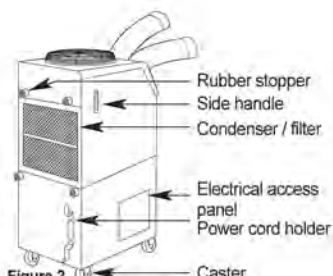

Figure 2  
Back and Left Side View

### POWER CORD HOLDER



Figure 3

1. Take out the cord holder from the accessory box.
2. Place the cord holder on the back side of air conditioner.
3. Use screws (enclosed inside of accessory box with cord holder) to install the cord holder on the air conditioner as shown in Figure 3.

### RUBBER STOPPERS



Figure 4

1. Take out the rubber stoppers from the accessory box.
2. Place the rubber stoppers on the back side of air conditioner.
3. Use screws (enclosed inside of accessory box with rubber stoppers) to install the rubber stoppers on the air conditioner as shown in Figure 4.

### DISCHARGE DUCTS/SUPPLY AIR DUCT



Figure 5

1. Remove cool air outlet hose(s) from carton.
2. Place the cool air outlet hose(s) on the front top of air conditioner.
3. Use screws (enclosed inside of box with cool air outlet hose(s)) to install the cool air outlet hose(s) on the air conditioner as shown in Figure 5.

### WARM AIR TOP EXHAUST DUCT



Figure 6

- (Optional)  
A warm air top exhaust duct can be purchased separately. Exhaust duct fits over the top exhaust fan duct improving cooling efficiency, allowing hot air to be exhausted to another location.
1. Remove duct from carton.
  2. Place duct on the top of air conditioner.
  3. Use screws (enclosed inside of box with duct) to install duct on air conditioner as shown in Figure 6.

## Assembly (Continued)

### REAR AMBIENT AIR ADAPTER (Optional)



Figure 7

- A rear ambient air adapter can be purchased separately. Air adapter fits over the condenser to duct condenser air to the unit to improve cooling efficiency.
1. Remove air adapter from carton.
  2. Place air adapter on the rear of air conditioner.
  3. Use screws (enclosed inside of box with air adapter) to install the adapter on the air conditioner as shown in Figure 7.

## Installation

### WARNINGS REGARDING PROPER LOCATION FOR INSTALLATION

- ▲ WARNING** Do not use the unit in explosive environments or in areas where flammable gas leakage may occur.
- ▲ WARNING** Do not use the unit in areas where it will be exposed to rain or water.
- ▲ WARNING** Do not use the unit in a corrosive atmosphere.
- ▲ WARNING** Do not use the unit above 18°C(64.4°F) ~ 45°C(113°F).
- ▲ WARNING** Do not install the unit on uneven or sloping surface. The unit may roll or topple over even if the casters are set to the locked position.

### MOVING THE UNIT

Unlock the casters and push the unit using the side handles to a flat, level surface and set the caster brakes to the locked position.

### PLUGGING IN THE UNIT

Check the prongs and surface of the power cord plug for dust/dirt. If dust and/or dirt are present, wipe off with a clean, dry cloth.

Check the power cord, plug and prongs for damage or excess play.

If any damage or excess play is found, contact a qualified repair technician or a qualified electrician to perform replacement or repair of the power cord, plug or prongs.

- ▲ WARNING** If the power cord or plug is damaged, repair should only be performed by qualified electrical personnel.
- ▲ WARNING** Do not connect / disconnect the power cord or attempt to operate buttons with wet hands. This could result in electrical shock.

**NOTE:** Make sure the AC outlet is free of dirt, dust, oil, water, or any other foreign material.

The unit is equipped with an approved NEMA plug configuration (700870: 5-15P, 700875: 6-15P, 700877: 6-20P). The appropriate outlet must be used for each plug type.



## Operation CONTROL PANEL

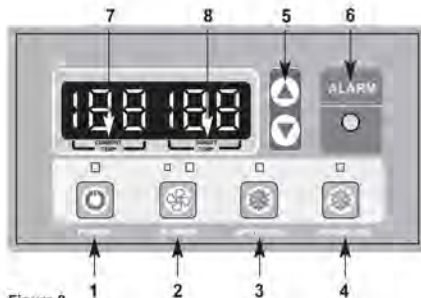

Figure 8

1. **POWER BUTTON:** Activates unit when POWER BUTTON is pressed. (Fan starts on low speed). If power button is pressed during operation, unit stops.
2. **BLOWER BUTTON:** Changes fan speed from (Low) to (High) when pressed.
3. **SPOT/COOL BUTTON:** Activates compressor and begins producing cool air 2 minutes after button is pressed. Regulates temperature based on outlet cool air temperature.
4. **ROOM/COOL BUTTON:** Activates compressor and produces cool air 2 minutes after button is pressed. Regulates temperature based on inlet ambient air temperature.
5. **SET TEMP BUTTONS:** Change target temperature/data value by +/- 1. Change data value by +/- 10 by pressing continually. Press the SET TEMP BUTTONS to set temperature. Upper button is to heighten temperature and Lower button is to lower temperature.
6. **ALARM:** Alarm indicator lights (blinks) and indicates abnormal system operation. If Alarm occurs, compressor stops. System operation stops when ALARM light is activated (blinks) longer than 3 minutes.
7. **CURRENT TEMP:** Displays current room temperature in display in Fahrenheit. (In Room Cool Mode only). SPOT/COOL Mode – Displays outlet (cool air) temperature during normal operations. In order to change °F to °C, press SPOT/COOL and ROOM/COOL buttons together for 2 seconds. C will blink 2 times and Figure will change to °C. ALARM codes blink and are displayed when abnormal operation occurs.
8. **TARGET TEMP** displays the unit set temperature for ROOMCOOL mode only.

## Maintenance

### FILTER CLEANING

(See Figures 9 and 10)

There are two filters in the unit. The evaporator filter is located at the front of the unit. The condenser filter is located at the rear of the unit.

1. To clean the evaporator filter, pull the front filter guard forward from top until the guard is open (in an angled position) and resting on the supporting cables.
2. Slide filter up and use a vacuum cleaner to remove the dust from the filter.
3. If the filter is heavily covered with dust and dirt, warm water and mild soap or neutral detergent may be used to wash the filter. Do not use any other chemicals to clean filter, as they will likely damage the filter.
4. Dry the filter in a shaded area before replacing it. Do not operate the unit without the filter installed and the filter guard in the closed position.
5. Replace the clean filter and close the filter guard.
6. To clean the condenser filter, lift up on the rear filter from the middle bar slightly and then angle the filter outwards from the bottom and remove.
7. Use the same cleaning procedure as above (3 – 5).
8. To replace the condenser filter, place the top of the filter in the guide and slide the filter up until the bottom of the filter clears the frame. Then push the bottom of filter into the guide and let filter gently fall inside the guide.

**NOTE:** For effective cooling clean the filter at least every 2 weeks.



Figure 9 – Removing Back Filter



**WARNING** Do not operate without the filter fitted.



**WARNING** Do not operate the unit with a damaged cord or plug, after the unit malfunctions, or if the unit has been dropped or damaged.



Figure 10 – Removal of Dust

- Remove dust from the filter using a vacuum cleaner hose attachment.
- If required wash the filter in lukewarm water with a mild detergent. Leave to dry in a shaded area before reinstalling.

– For your convenience, record the complete model number and product name (located on the Product Identification Plate), the purchase date, purchase location, serial number, and warranty period in the table below.

– Also, attach your purchase receipt as proof of purchase to this instruction manual for future reference.

## Maintenance (Continued)

– To ensure your product is covered by warranty, the complete faulty product along with your original purchase receipt must be provided at the place of purchase.

Product Portable Air Conditioner

Model No. \_\_\_\_\_  
 Date of Purchase \_\_\_\_\_  
 Place of Purchase \_\_\_\_\_  
 Serial No. \_\_\_\_\_  
 Period of Warranty \_\_\_\_\_

**Customer:** Please read and keep this manual for future reference and keep sales receipt as proof of purchase.

### SPRING REPLACEMENT

(See Figure 11)

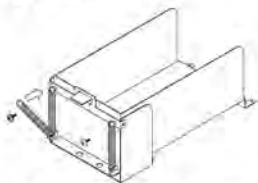

Figure 11 – The process of spring replacement

There are two springs on the rear of condensate water tank guide.

1. Release the screw on the spring hook.
2. Take off the spring hook, and then pull out the opposite spring hook from hole in the condensate water tank guide.
3. Replace with a new spring in reverse order.
4. Repeat this cycle for the other spring.

### SELF-DIAGNOSTIC CODES

(See Table 1)

The alarm light is activated if abnormal operation occurs, and a code is displayed on the control panel. The compressor and condenser fan motor will stop operating. The evaporator fan will continue to run for 3 minutes. If the fault is rectified within 3 minutes, the unit will resume operation. If the fault persists for more than 3 minutes, the evaporator fan also stops. The fault must be rectified before the unit can resume normal operation.

### SELF-DIAGNOSTIC CODES

Alarm Display	Problem	Cause	Corrective Action
	Frost prevention sensor and Abnormal temperature sensor value	a. Indoor heat exchanger temperature too low b. TH3 temperature sensor has a loose or broken connection	a. Do not use the air conditioner if ambient temperature is lower than 18°C (64°F) b. Contact a qualified service agent
	Refrigerant high pressure switch	a. Blocked air filter b. Blocked / kinked exhaust duct c. Ambient temperature is too high	a. Clean air filter b. Ensure exhaust duct is not blocked / kinked c. Do not use the air conditioner if ambient temperature is higher than 45°C (113°F)
	Abnormal temperature sensor value	TH1(Outlet) temperature sensor has a loose or broken connection	Contact a qualified service agent
	Abnormal temperature sensor value	TH2(Inlet) temperature sensor has a loose or broken connection	Contact a qualified service agent
	Compressor overloaded	a. Ambient temperature is too high b. Unstable voltage supply c. Defective compressor	a. Do not use the air conditioner if ambient temperature is higher than 45°C (113°F) b. Contact a qualified service agent c. Replace compressor
	Condensate water level alarm	a. Condensate tank is full	a. Empty the water tank b. After installation of the water tank, press the SPOT/COOL or ROOM/COOL button to resume operation

Table 1 – Alarm Codes

## Wiring Diagram

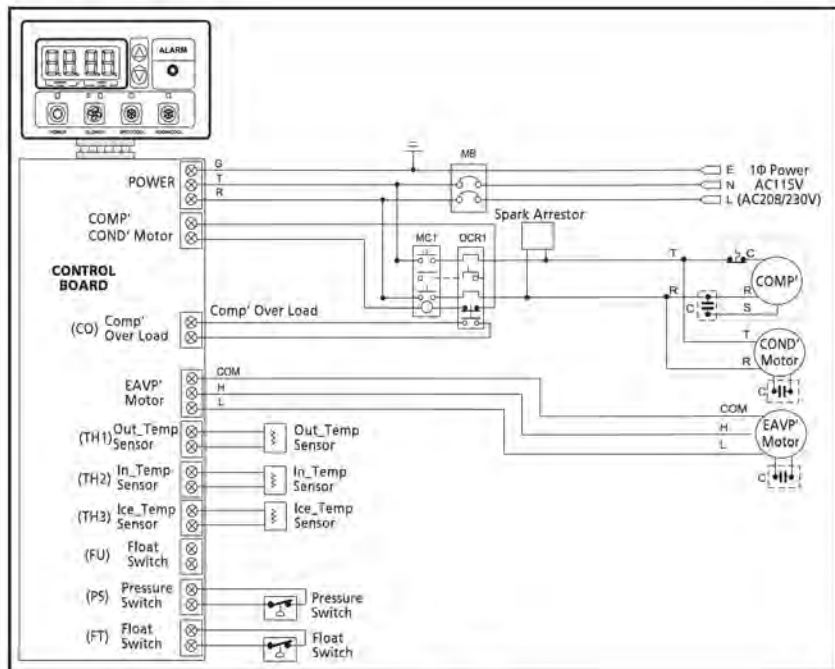
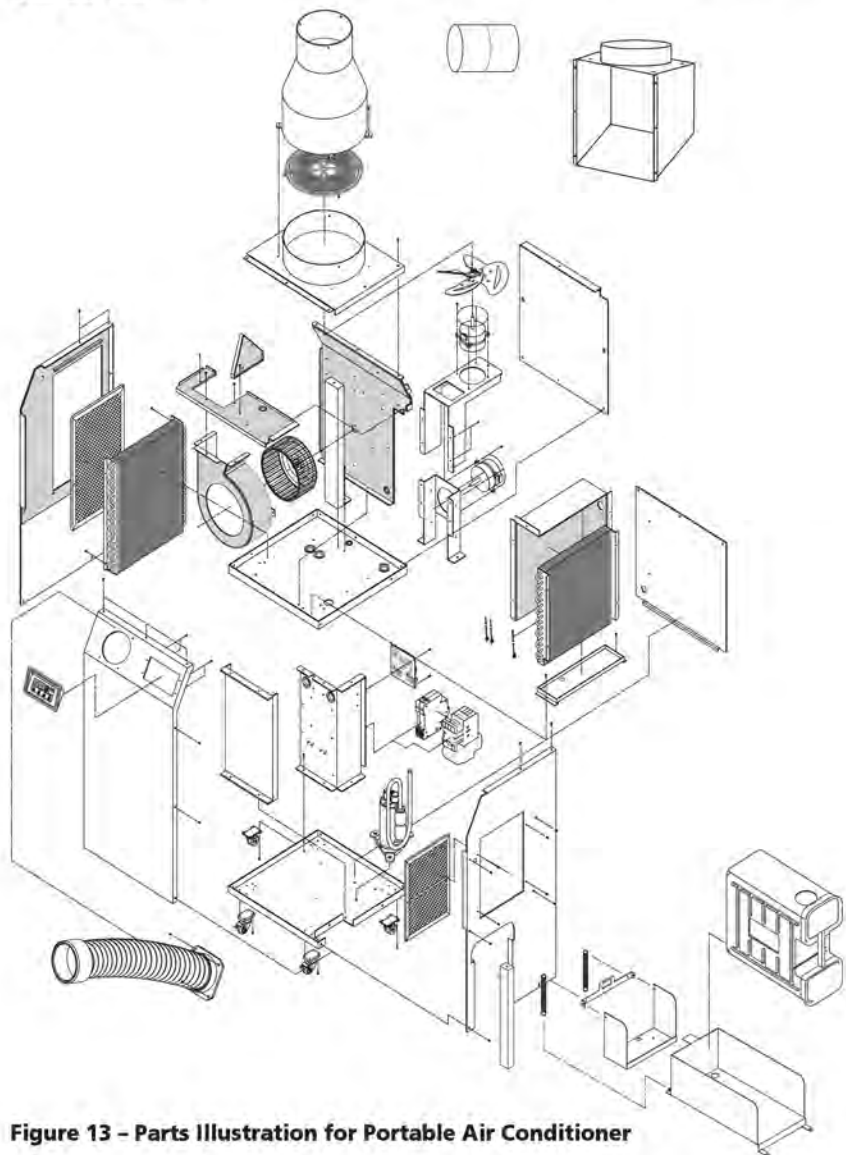

Figure 12 - Circuit Wiring Diagram (Models 700870 / 700875 / 700877)

## Troubleshooting chart

Symptom	Possible Cause(s)	Corrective Action
Water leakage	High water level in condensate tank	<ol style="list-style-type: none"> <li>1. Remove blockage from drain hose</li> <li>2. Remove any object stuck underneath of the black panel under the water tank</li> </ol>
The unit doesn't work	<ol style="list-style-type: none"> <li>1. Check the power supply to verify that power is available to the unit</li> <li>2. Verify that the power cord is connected</li> </ol>	<ol style="list-style-type: none"> <li>1. Reset the circuit breaker and restart the unit</li> <li>2. Connect power cord</li> </ol>
No cold air flows from the cold air outlet	<ol style="list-style-type: none"> <li>1. Ambient air cannot be properly cooled if the filter is dirty and not regularly cleaned</li> <li>2. Only the fan operates for 2 minutes after the unit has been started to protect the unit</li> <li>3. The ambient air temperature may be too high</li> </ol>	<ol style="list-style-type: none"> <li>1. Clean the filter</li> <li>2. Verify that 2 minutes has passed since the unit was turned on</li> <li>3. The temperature of the compressor can be higher when the ambient temperature is too high. The compressor will not work unless the ambient air temperature is within the acceptable operating range of the unit</li> </ol>
Water flow can be heard after compressor shuts off	No cause	Common to hear coolant flowing after unit shuts off
Alarm displays "FT" with less than half of condensate water in the tank	Spring is possibly broken	Replace a new spring (See Maintenance page 8)
Spring is possibly broken		



**Figure 13 – Parts Illustration for Portable Air Conditioner**

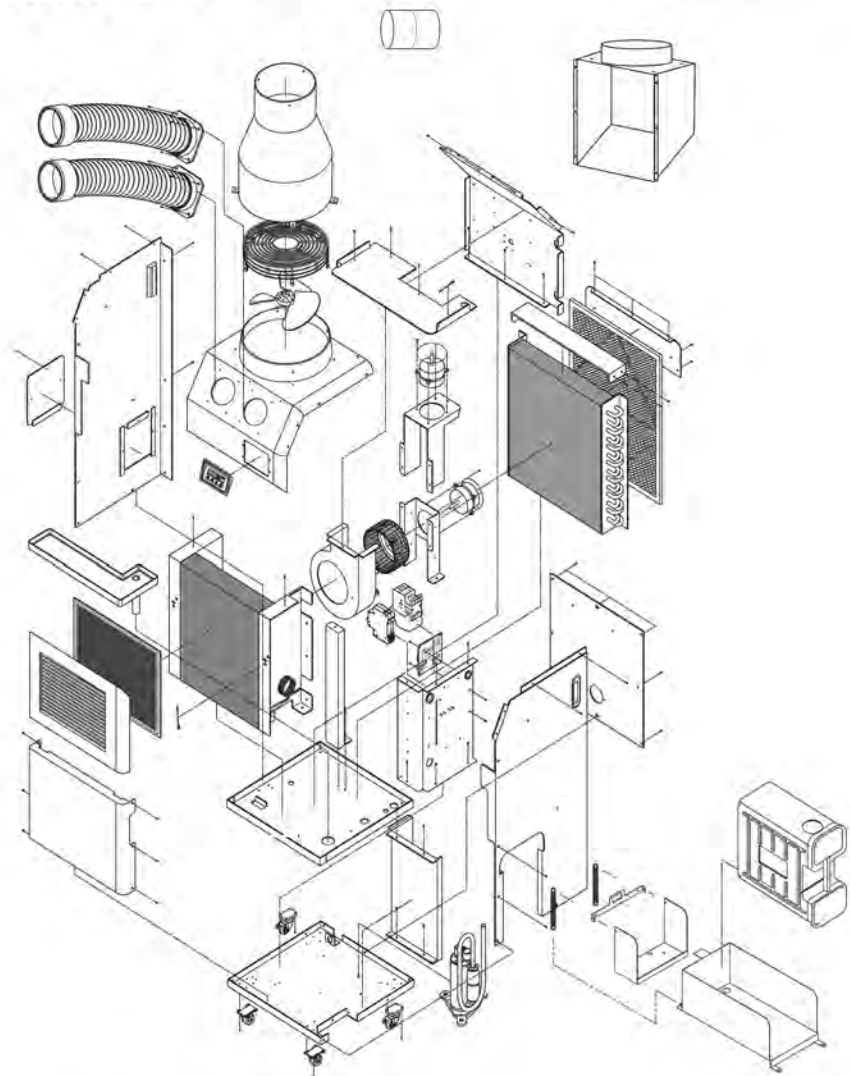

**Figure 14 – Parts Illustration for Portable Air Conditioner**

