

INSTALLATION SHEET : RHA-UNV-242-K

This Is An Original Product From Fulham Co., Inc

Description: This Kit contains a Universal Voltage CFL Electronic Ballast, which features Program Start, End-Of-Life Protection (EOL), Flicker-Free Operation, and Auto-Restart. Includes Ballast, Snap-on-plate, Required Wires, Wire Removing Tool, Nuts and Screws. Numerous Applications, such as retrofit down light.

Safety, Warning and Suggestions

(1) Qualified electrician is required to install this product/s. (2) To prevent electrical shock and injury, be sure to disconnect power prior to mounting of this fixture/s. (3) All wiring and installations should meet local, state and national electrical codes. (4) Install correct lamp type and wattage.

This Ballast Will Operate Following Lamps.

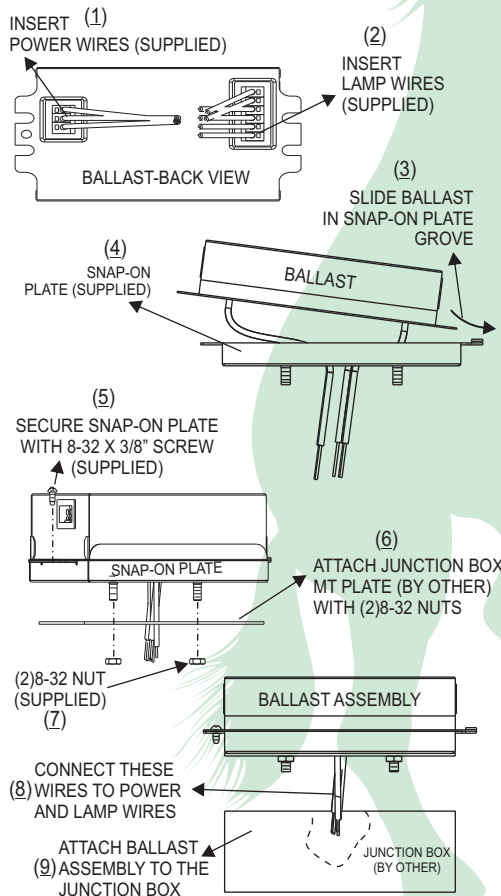
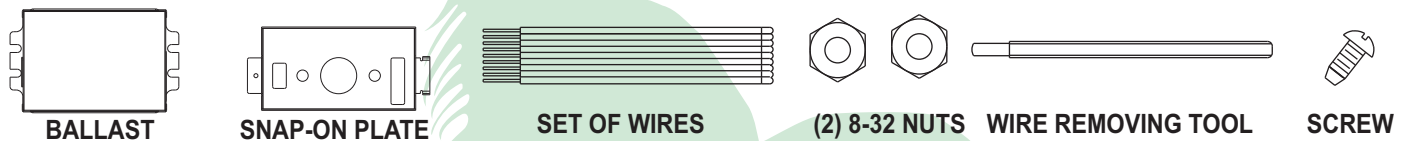
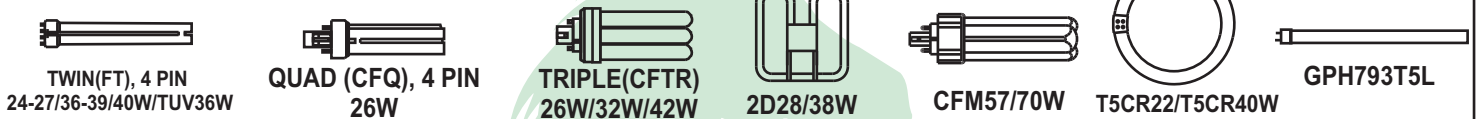

Las Instrucciones En Español.

- 1) insertar los alambres de la energía (proveída).
- 2) insertar los alambres de la lámpara (proveída).
- 3) resbalar el lastre en arboleda.
- 4) placa snap-on (proveída)
- 5) asegurar la placa snap-on con 8-32 x 3/8 " tornillo (proveída).
- 6) unir la placa MT con la caja de ensambladura con (2) 8-32 tuercas
- 7) (2) tuerca 8-32 (proveída).
- 8) Conecte Estos Alambres Con La Energía y Los Alambres De La Lámpara.
- 9) unir el montaje del lastre a la caja de ensambladura.

L'instruction d'installation en français

- 1) INSÉREZ LES FILS CONDUCTEUR (FOURNIS)
- 2) INSÉREZ LES FILS DE LAMPES (FOURNIS)
- 3) GLISSEZ LE BALLAST DANS LA FENTE DE LA PLAQUE "SNAP-ON"
- 4) PLAQUE "SNAP-ON" (FOURNIS)
- 5) VISSEZ LA PLAQUE "SNAP-ON" AVEC DES VIS 8.32X3/8" (FOURNIS)
- 6) INSTALLEZ LA BOITE DE JONCTION A LA PLAQUE DE MONTAGE AVEC DES ÉCROUS (2) 8-32
- 7) (2) ÉCROUS 8-32 (FOURNIS)
- 8) RACCORDEZ CES FILS AUX FILS CONDUCTEUR ET AUX FILS DE LAMPES
- 9) UNISSEZ LE BALLAST À LA BOITE DE JONCTION

Fulham Co., Inc extends limited warranty only to the original purchaser or to the first user for the period of 3 years @ 90° C & 5 years @ 70° C from the date of manufacture as indicated by the date code stamped on each product and when properly installed and under normal conditions of use. For additional warranty guide line, please refer to our Complete Product Catalog OR call Customer Service at 1-323-599-5000.

DUE TO A PROGRAM OF CONTINUOUS IMPROVEMENT, FULHAM Co., INC RESERVES THE RIGHT TO MAKE ANY VARIATION IN DESIGN OR CONSTRUCTION TO THE EQUIPMENT DESCRIBED. Address : 12705 South Van Ness Ave., Hawthorne, CA 90250 Tel.: 1-323-599-5000, Fax.: 1-323-754-9060. Website: www.fulham.com

2013-393 REV

SPECIFICATION SHEET : RHA-UNV-242-C

This Is An Original Product From Fulham Co., Inc

Description : RACEHORSE Series, Universal Operating Voltage, Program Preheat Start Ballast, End Of Life Protection, Auto Restart, Cold Starting Feature.

This Ballast Will Operate Following Lamps.



TWIN(FT), 4 PIN
24-27/36-39/40W/TUV36W



QUAD (CFQ), 4 PIN
26W



TRIPLE(CFTR)
26W/32W/42W



2D28/38W

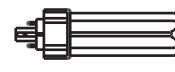

CFM57/70W

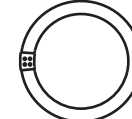

T5CR22/T5CR40W

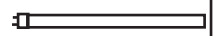

GPH793T5L

ELECTRICAL DATA (With 120 Volt Application)

INPUT VOLT: 120V ± 10% , 50/60Hz									
LAMP WATTS/TYPE	CFTR42W	FT24/27W	FT36/39W	FT40W	2D28W	2D38W	T5CR40W	TUV36W	GPH793T5L
LAMPS OPERATED	1								
INPUT WATTS	46	25	32	44	31	34	41	33	29
LINE CURRENT:	0.39	0.21	0.27	0.36	0.26	0.28	0.34	0.28	0.24
POWER FACTOR	0.99	0.99	0.99	0.99	0.99	0.99	0.99	0.99	0.99
BALLAST FACTOR	0.95	1.02	0.85	0.95	1.22	0.83	0.92	0.69	0.72
EFFICACY FACTOR	2.04	4.03	2.62	2.18	3.88	2.48	2.23	2.09	2.48
THD	8.7%	12.3%	10.4%	9.3%	10.0%	10.0%	9.5%	10.0%	10.9%
CURRENT CREST FACTOR	< 1.7								
EMI/RFI COMPLIANCE	FCC PART 18-A (NON-CONSUMER)								
SOUND RATING	" A "								
BALLAST TYPE	PROGRAMMED START								
VOLTAGE TRANSIENTS	MOV (ANSI C82.11)								
INPUT/PROTECTION	FUSE								
OUTPUT/PROTECTION	OPEN LAMP, SHORTED LAMP, END-OF-LIFE								
MIN. OPERATING TEMP	-30°C (-22°F)								
MAX. CASE TEMP	90°C (194°F) SEE FOOT NOTE WARRANTY								
APPROVALS/CLASS	UL /cUL LISTED, CLASS " P ", 1 OUTDOOR								
REMOTE MOUNTING	18 FT MAX.								

MECHANICAL DATA

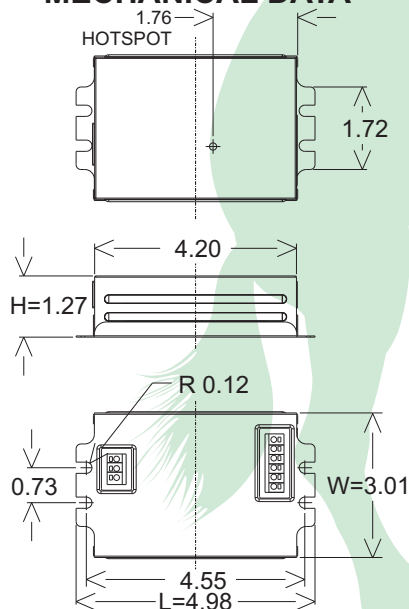

Where : L = Length, W = Width, H = Height

WIRING DIAGRAMS

1 X CFM57/70W, FT24-27/36-39/40W, TUV36W, CFTR42W, 2D28/38W, T5CR40W, GPH793T5L

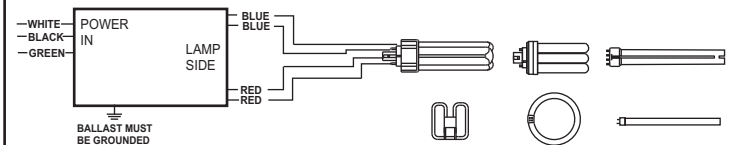

2 X FT24-27/36-39/40W, TUV36W, CFQ26W, CFTR26/32/42W, 2D28/38W T5CR22/40W, GPH793T5L

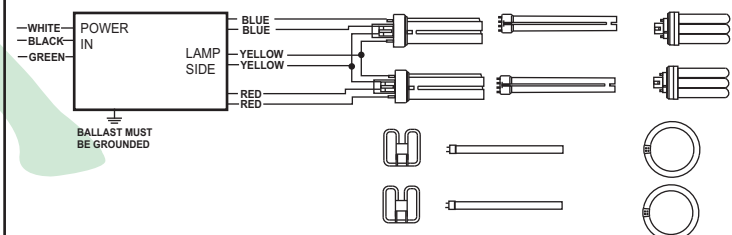

NOTE : This Ballast Must Be Grounded

Fulham extends a limited warranty only to the original purchaser or to the first user for a period of 3 years @ 90°C & 5 years @ 75°C from the date of manufacture when properly installed and operated under normal conditions of use. For complete terms and conditions, please reference the Fulham product catalog (www.fulham.com) **Due to a program of continuous improvement, Fulham reserves the right to make modifications or variations in design or construction to the equipment described.**

SPECIFICATION SHEET : RHA-UNV-242-C

This Is An Original Product From Fulham Co., Inc

Description : RACEHORSE Series, Universal Operating Voltage, Program Preheat Start Ballast, End Of Life Protection, Auto Restart, Cold Starting Feature.

This Ballast Will Operate Following Lamps.



TWIN(FT), 4 PIN
24-27/36-39/40W/TUV36W



QUAD (CFQ), 4 PIN
26W



TRIPLE(CFTR)
26W/32W/42W



2D28/38W



CFM57/70W

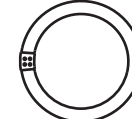

T5CR22/T5CR40W

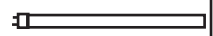

GPH793T5L

ELECTRICAL DATA (With 120 Volt Application)

INPUT VOLT: 120V ± 10%, 50/60Hz									
LAMP WATTS/TYPE	CFM57W	CFM70W	CFQ26W	CFTR26W	CFTR32W	CFTR42W	FT24/27W	FT36/39W	FT40W
LAMPS OPERATED	1			2					
INPUT WATTS	55	69	53	56	59	89	48	62	87
LINE CURRENT:	0.46	0.57	0.44	0.46	0.49	0.74	0.40	0.52	0.72
POWER FACTOR	0.99	0.99	0.99	0.99	0.99	0.99	0.99	0.99	0.99
BALLAST FACTOR	0.94	0.94	0.97	0.97	0.91	0.90	0.98	0.81	0.89
EFFICACY FACTOR	1.71	1.36	1.82	1.74	1.54	1.01	2.03	1.30	1.02
THD	8.4%	7.5%	7.9%	7.6%	7.6%	6.6%	8.2%	7.1%	6.4%
CURRENT CREST FACTOR	< 1.7								
EMI/RFI COMPLIANCE	FCC PART 18-A (NON-CONSUMER)								
SOUND RATING	" A "								
BALLAST TYPE	PROGRAMMED START								
VOLTAGE TRANSIENTS	MOV (ANSI C82.11)								
INPUT/PROTECTION	FUSE								
OUTPUT/PROTECTION	OPEN LAMP, SHORTED LAMP, END-OF-LIFE								
MIN. OPERATING TEMP	-30°C (-22°F)								
MAX. CASE TEMP	90°C (194°F) SEE FOOT NOTE WARRANTY								
APPROVALS/CLASS	UL /cUL LISTED, CLASS " P ", 1 OUTDOOR								
REMOTE MOUNTING	18 FT MAX.								

MECHANICAL DATA

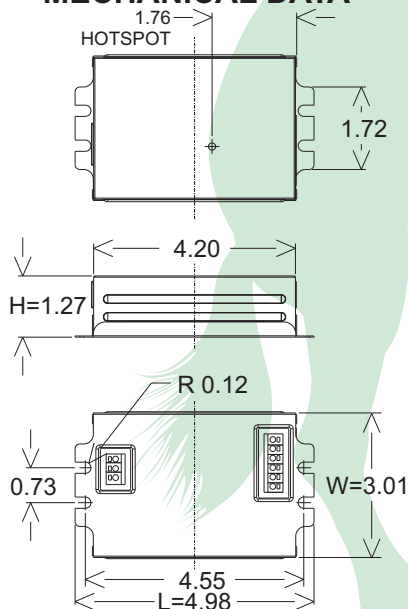

Where : L = Length, W = Width, H = Height

WIRING DIAGRAMS

1 X CFM57/70W, FT24-27/36-39/40W, TUV36W, CFTR42W, 2D28/38W, T5CR40W, GPH793T5L

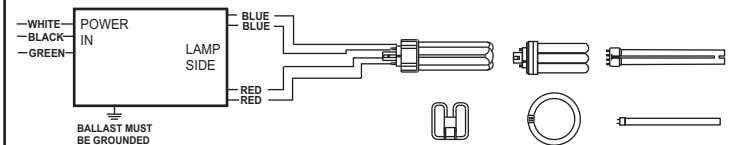

2 X FT24-27/36-39/40W, TUV36W, CFQ26W, CFTR26/32/42W, 2D28/38W T5CR22/40W, GPH793T5L

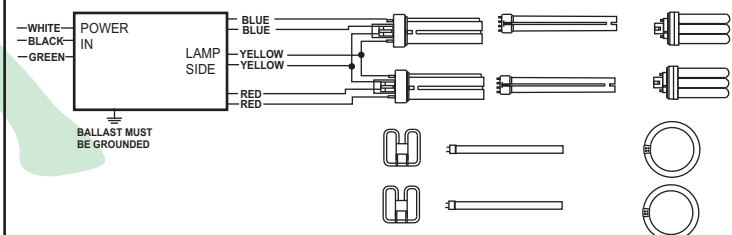

NOTE : This Ballast Must Be Grounded

Fulham extends a limited warranty only to the original purchaser or to the first user for a period of 3 years @ 90°C & 5 years @ 75°C from the date of manufacture when properly installed and operated under normal conditions of use. For complete terms and conditions, please reference the Fulham product catalog (www.fulham.com) **Due to a program of continuous improvement, Fulham reserves the right to make modifications or variations in design or construction to the equipment described.**

SPECIFICATION SHEET : RHA-UNV-242-C

This Is An Original Product From Fulham Co., Inc

Description : RACEHORSE Series, Universal Operating Voltage, Program Preheat Start Ballast, End Of Life Protection, Auto Restart, Cold Starting Feature.

This Ballast Will Operate Following Lamps.



TWIN(FT), 4 PIN
24-27/36-39/40W/TUV36W



QUAD (CFQ), 4 PIN
26W



TRIPLE(CFTR)
26W/32W/42W



2D28/38W

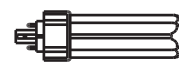

CFM57/70W

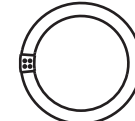

T5CR22/T5CR40W

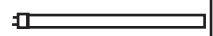

GPH793T5L

ELECTRICAL DATA (With 120 Volt Application)

INPUT VOLT: 120V ± 10%, 50/60Hz							
LAMP WATTS/TYPE	2D28W	2D38W	T5CR22W	T5CR40W	TUV36W	GPH793T5L	
LAMPS OPERATED	2						
INPUT WATTS	61	63	50	79	64	55	
LINE CURRENT:	0.51	0.53	0.41	0.66	0.53	0.45	
POWER FACTOR	0.99	0.99	0.99	0.99	0.99	0.99	
BALLAST FACTOR	1.16	0.82	0.98	0.90	0.66	0.69	
EFFICACY FACTOR	1.91	1.30	1.97	1.14	1.03	1.26	
THD	7.4%	7.0%	8.7%	6.9%	7.2%	7.8%	
CURRENT CREST FACTOR	< 1.7						
EMI/RFI COMPLIANCE	FCC PART 18-A (NON-CONSUMER)						
SOUND RATING	" A "						
BALLAST TYPE	PROGRAMMED START						
VOLTAGE TRANSIENTS	MOV (ANSI C82.11)						
INPUT/PROTECTION	FUSE						
OUTPUT/PROTECTION	OPEN LAMP, SHORTED LAMP, END-OF-LIFE						
MIN. OPERATING TEMP	-30°C (-22°F)						
MAX. CASE TEMP	90°C (194°F) SEE FOOT NOTE WARRANTY						
APPROVALS/CLASS	UL /cUL LISTED, CLASS " P ", 1 OUTDOOR						
REMOTE MOUNTING	18 FT MAX.						

MECHANICAL DATA

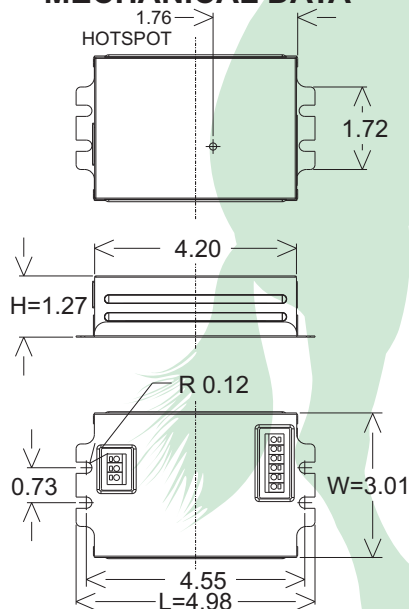

Where : L = Length, W = Width, H = Height

WIRING DIAGRAMS

1 X CFM57/70W, FT24-27/36-39/40W, TUV36W, CFTR42W, 2D28/38W, T5CR40W, GPH793T5L

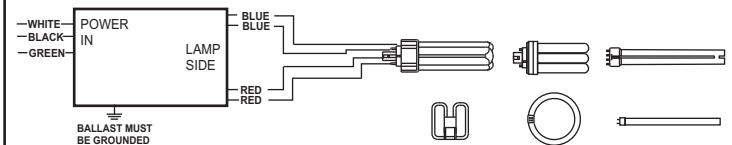

2 X FT24-27/36-39/40W, TUV36W, CFQ26W, CFTR26/32/42W, 2D28/38W T5CR22/40W, GPH793T5L

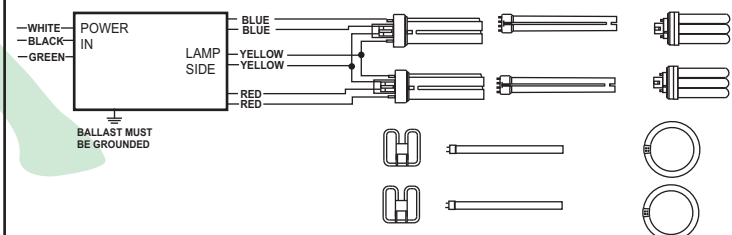

NOTE : This Ballast Must Be Grounded

Fulham extends a limited warranty only to the original purchaser or to the first user for a period of 3 years @ 90°C & 5 years @ 75°C from the date of manufacture when properly installed and operated under normal conditions of use. For complete terms and conditions, please reference the Fulham product catalog (www.fulham.com) Due to a program of continuous improvement, Fulham reserves the right to make modifications or variations in design or construction to the equipment described.

SPECIFICATION SHEET : RHA-UNV-242-C

This Is An Original Product From Fulham Co., Inc

Description : RACEHORSE Series, Universal Operating Voltage, Program Preheat Start Ballast, End Of Life Protection, Auto Restart, Cold Starting Feature.

This Ballast Will Operate Following Lamps.



TWIN(FT), 4 PIN
24-27/36-39/40W/TUV36W



QUAD (CFQ), 4 PIN
26W



TRIPLE(CFTR)
26W/32W/42W



2D28/38W

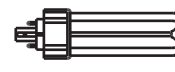

CFM57/70W

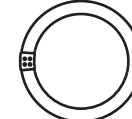

T5CR22/T5CR40W

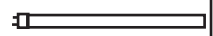

GPH793T5L

ELECTRICAL DATA (With 277 Volt Application)

INPUT VOLT: 277V ± 10%, 50/60Hz									
LAMP WATTS/TYPE	CFTR42W	FT24/27W	FT36/39W	FT40W	2D28W	2D38W	T5CR40W	TUV36W	GPH793T5L
LAMPS OPERATED	1								
INPUT WATTS	46	25	32	43	32	34	41	33	29
LINE CURRENT:	0.18	0.11	0.13	0.17	0.13	0.14	0.16	0.13	0.12
POWER FACTOR	0.94	0.83	0.89	0.93	0.89	0.90	0.93	0.90	0.87
BALLAST FACTOR	0.95	1.02	0.85	0.95	1.22	0.83	0.92	0.69	0.72
EFFICACY FACTOR	2.08	4.04	2.62	2.21	3.84	2.46	2.27	2.08	2.49
THD	16.8%	21.7%	16.7%	16.9%	18.6%	17.1%	15.4%	17.3%	18.5%
CURRENT CREST FACTOR	< 1.7								
EMI/RFI COMPLIANCE	FCC PART 18-A (NON-CONSUMER)								
SOUND RATING	" A "								
BALLAST TYPE	PROGRAMMED START								
VOLTAGE TRANSIENTS	MOV (ANSI C82.11)								
INPUT/PROTECTION	FUSE								
OUTPUT/PROTECTION	OPEN LAMP, SHORTED LAMP, END-OF-LIFE								
MIN. OPERATING TEMP	-30°C (-22°F)								
MAX. CASE TEMP	90°C (194°F) SEE FOOT NOTE WARRANTY								
APPROVALS/CLASS	UL /cUL LISTED, CLASS " P ", 1 OUTDOOR								
REMOTE MOUNTING	18 FT MAX.								

MECHANICAL DATA

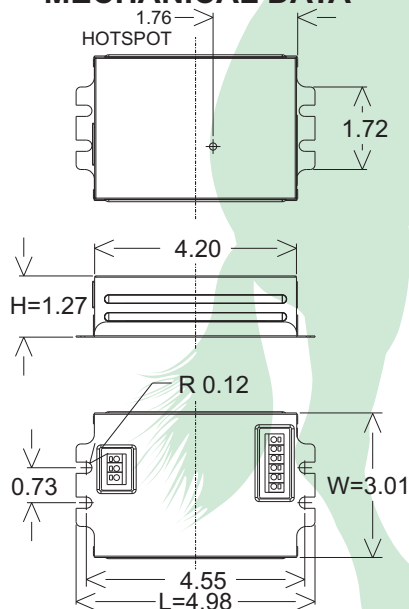

Where : L = Length, W = Width, H = Height

WIRING DIAGRAMS

1 X CFM57/70W, FT24-27/36-39/40W, TUV36W, CFTR42W, 2D28/38W, T5CR40W, GPH793T5L

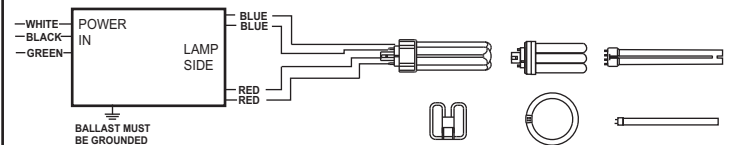

2 X FT24-27/36-39/40W, TUV36W, CFQ26W, CFTR26/32/42W, 2D28/38W T5CR22/40W, GPH793T5L

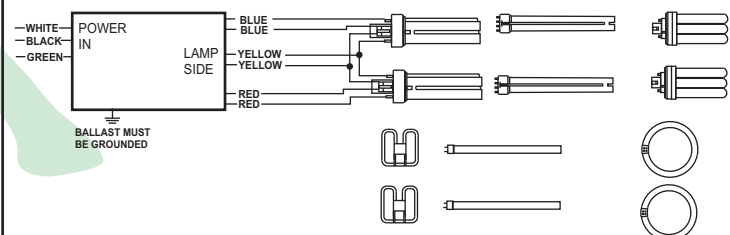

NOTE : This Ballast Must Be Grounded

Fulham extends a limited warranty only to the original purchaser or to the first user for a period of 3 years @ 90°C & 5 years @ 75°C from the date of manufacture when properly installed and operated under normal conditions of use. For complete terms and conditions, please reference the Fulham product catalog (www.fulham.com) Due to a program of continuous improvement, Fulham reserves the right to make modifications or variations in design or construction to the equipment described.

SPECIFICATION SHEET : RHA-UNV-242-C

This Is An Original Product From Fulham Co., Inc

Description : RACEHORSE Series, Universal Operating Voltage, Program Preheat Start Ballast, End Of Life Protection, Auto Restart, Cold Starting Feature.

This Ballast Will Operate Following Lamps.



TWIN(FT), 4 PIN
24-27/36-39/40W/TUV36W



QUAD (CFQ), 4 PIN
26W



TRIPLE(CFTR)
26W/32W/42W



2D28/38W



CFM57/70W

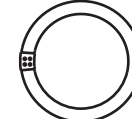

T5CR22/T5CR40W

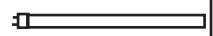

GPH793T5L

ELECTRICAL DATA (With 277 Volt Application)

INPUT VOLT: 277V ± 10%, 50/60Hz									
LAMP WATTS/TYPE	CFM57W	CFM70W	CFQ26W	CFTR26W	CFTR32W	CFTR42W	FT24/27W	FT36/39W	FT40W
LAMPS OPERATED	1			2					
INPUT WATTS	56	67	53	55	58	86	48	61	85
LINE CURRENT:	0.21	0.25	0.20	0.21	0.22	0.32	0.18	0.23	0.31
POWER FACTOR	0.95	0.97	0.95	0.95	0.96	0.98	0.94	0.96	0.98
BALLAST FACTOR	0.94	0.94	0.97	0.97	0.91	0.90	0.98	0.81	0.89
EFFICACY FACTOR	1.69	1.40	1.83	1.76	1.58	1.04	2.04	1.32	1.04
THD	14.7%	11.4%	16.0%	14.6%	14.6%	9.6%	16.6%	12.2%	9.9%
CURRENT CREST FACTOR	< 1.7								
EMI/RFI COMPLIANCE	FCC PART 18-A (NON-CONSUMER)								
SOUND RATING	" A "								
BALLAST TYPE	PROGRAMMED START								
VOLTAGE TRANSIENTS	MOV (ANSI C82.11)								
INPUT/PROTECTION	FUSE								
OUTPUT/PROTECTION	OPEN LAMP, SHORTED LAMP, END-OF-LIFE								
MIN. OPERATING TEMP	-30°C (-22°F)								
MAX. CASE TEMP	90°C (194°F) SEE FOOT NOTE WARRANTY								
APPROVALS/CLASS	UL /cUL LISTED, CLASS " P ", 1 OUTDOOR								
REMOTE MOUNTING	18 FT MAX.								

MECHANICAL DATA

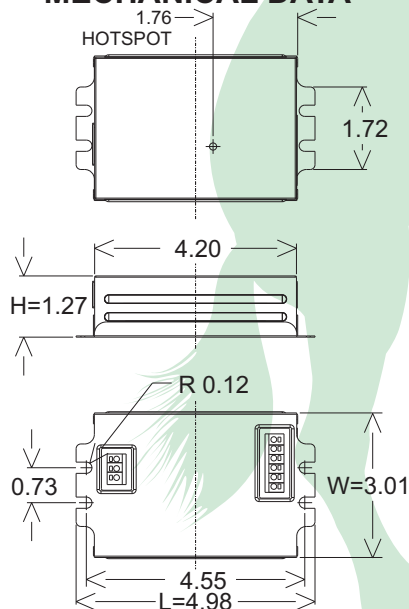

Where : L = Length, W = Width, H = Height

WIRING DIAGRAMS

1 X CFM57/70W, FT24-27/36-39/40W, TUV36W, CFTR42W, 2D28/38W, T5CR40W, GPH793T5L

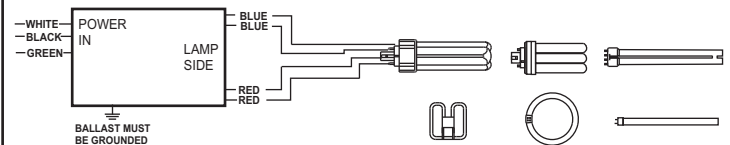

2 X FT24-27/36-39/40W, TUV36W, CFQ26W, CFTR26/32/42W, 2D28/38W T5CR22/40W, GPH793T5L

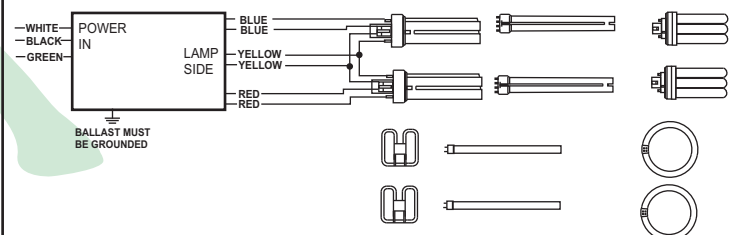

NOTE : This Ballast Must Be Grounded

Fulham extends a limited warranty only to the original purchaser or to the first user for a period of 3 years @ 90°C & 5 years @ 75°C from the date of manufacture when properly installed and operated under normal conditions of use. For complete terms and conditions, please reference the Fulham product catalog (www.fulham.com) **Due to a program of continuous improvement, Fulham reserves the right to make modifications or variations in design or construction to the equipment described.**

SPECIFICATION SHEET : RHA-UNV-242-C

This Is An Original Product From Fulham Co., Inc

Description : RACEHORSE Series, Universal Operating Voltage, Program Preheat Start Ballast, End Of Life Protection, Auto Restart, Cold Starting Feature.

This Ballast Will Operate Following Lamps.



TWIN(FT), 4 PIN
24-27/36-39/40W/TUV36W



QUAD (CFQ), 4 PIN
26W



TRIPLE(CFTR)
26W/32W/42W



2D28/38W

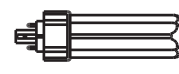

CFM57/70W

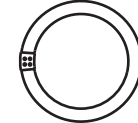

T5CR22/T5CR40W

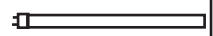

GPH793T5L

ELECTRICAL DATA (With 277 Volt Application)

INPUT VOLT: 277V ± 10%, 50/60Hz							
LAMP WATTS/TYPE	2D28W	2D38W	T5CR22W	T5CR40W	TUV36W	GPH793T5L	
LAMPS OPERATED	2						
INPUT WATTS	59	62	49	77	63	54	
LINE CURRENT:	0.22	0.23	0.19	0.29	0.24	0.20	
POWER FACTOR	0.96	0.97	0.94	0.98	0.97	0.95	
BALLAST FACTOR	1.16	0.82	0.98	0.90	0.66	0.69	
EFFICACY FACTOR	14.9%	12.5%	16.3%	10.4%	12.3%	15.3%	
THD	10.0%						
CURRENT CREST FACTOR	< 1.7						
EMI/RFI COMPLIANCE	FCC PART 18-A (NON-CONSUMER)						
SOUND RATING	" A "						
BALLAST TYPE	PROGRAMMED START						
VOLTAGE TRANSIENTS	MOV (ANSI C82.11)						
INPUT/PROTECTION	FUSE						
OUTPUT/PROTECTION	OPEN LAMP, SHORTED LAMP, END-OF-LIFE						
MIN. OPERATING TEMP	-30°C (-22°F)						
MAX. CASE TEMP	90°C (194°F) SEE FOOT NOTE WARRANTY						
APPROVALS/CLASS	UL /cUL LISTED, CLASS " P ", 1 OUTDOOR						
REMOTE MOUNTING	18 FT MAX.						

MECHANICAL DATA

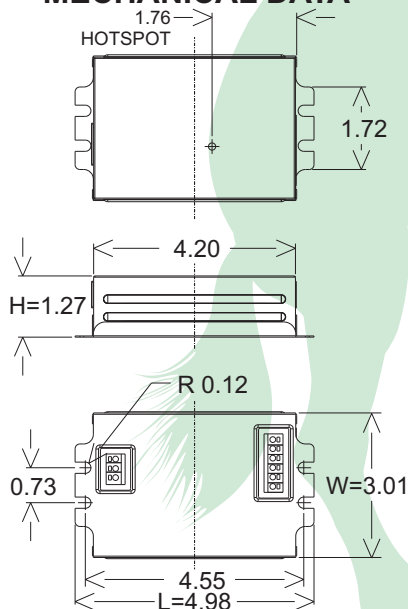

Where : L = Length, W = Width, H = Height

WIRING DIAGRAMS

1 X CFM57/70W, FT24-27/36-39/40W, TUV36W, CFTR42W, 2D28/38W, T5CR40W, GPH793T5L

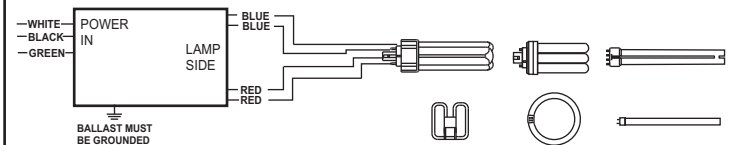

2 X FT24-27/36-39/40W, TUV36W, CFQ26W, CFTR26/32/42W, 2D28/38W T5CR22/40W, GPH793T5L

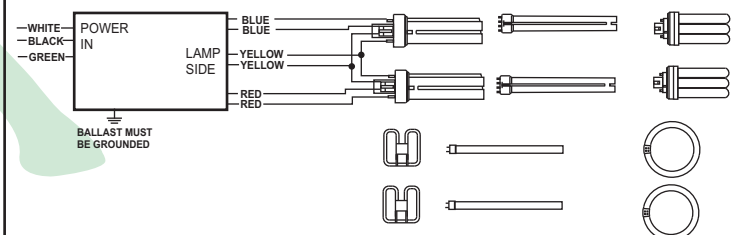

NOTE : This Ballast Must Be Grounded

Fulham extends a limited warranty only to the original purchaser or to the first user for a period of 3 years @ 90°C & 5 years @ 75°C from the date of manufacture when properly installed and operated under normal conditions of use. For complete terms and conditions, please reference the Fulham product catalog (www.fulham.com) Due to a program of continuous improvement, Fulham reserves the right to make modifications or variations in design or construction to the equipment described.