

INSTALLATION SHEET : RHA-UNV-218-K

This Is An Original Product From Fulham Co., Inc

Description: This Kit contains a Universal Voltage CFL Electronic Ballast, which features Program Start, End-Of-Life Protection (EOL), Flicker-Free Operation, and Auto-Restart. Includes Ballast, Snap-on-plate, Required Wires, Wire Removing Tool, Nuts and Screws. Numerous Applications, such as retrofit down light.

Safety, Warning and Suggestions

(1) Qualified electrician is required to install this product/s. (2) To prevent electrical shock and injury, be sure to disconnect power prior to mounting of this fixture/s. (3) All wiring and installations should meet local, state and national electrical codes. (4) Install correct lamp type and wattage.

This Ballast Will Operate Following Lamps.

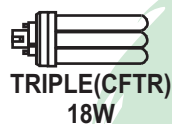
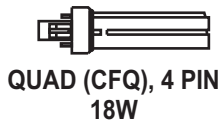

List Of Item Enclosed

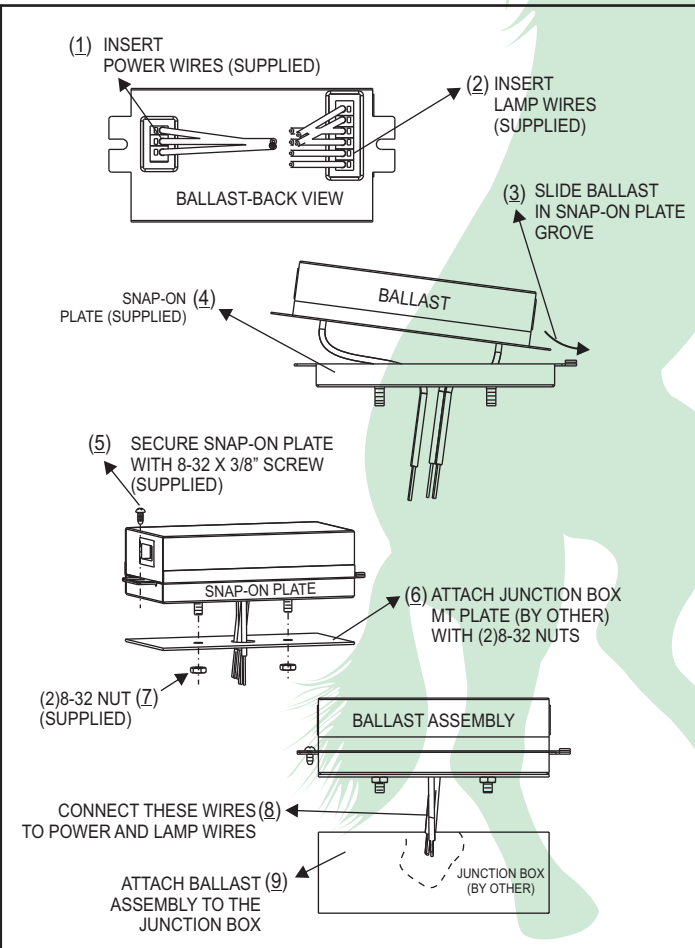
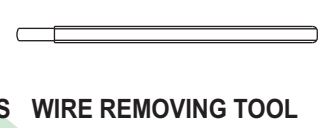
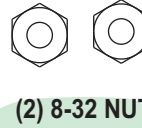
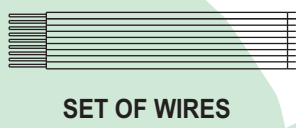

Las Instrucciones En Español.

- 1) insertar los alambres de la energía (proveída).
- 2) insertar los alambres de la lámpara (proveída).
- 3) resbalar el lastre en arboleda.
- 4) placa snap-on (proveída)
- 5) asegurar la placa snap-on con 8-32 x 3/8 " tornillo (proveída).
- 6) unir la placa MT con la caja de ensambladura con (2) 8-32 tuercas
- 7) (2) tuerca 8-32 (proveída).
- 8) Conecte Estos Alambres Con La Energía y Los Alambres De La Lámpara.
- 9) unir el montaje del lastre a la caja de ensambladura.

L'instruction d'installation en français

- 1) INSÉREZ LES FILS CONDUCTEUR (FOURNIS)
- 2) INSÉREZ LES FILS DE LAMPES (FOURNIS)
- 3) GLISSEZ LE BALLAST DANS LA FENTE DE LA PLQUE "SNAP-ON"
- 4) PLAQUE "SNAP-ON" (FOURNIS)
- 5) VISSEZ LA PLAQUE "SNAP-ON" AVEC DES VIS 8.32X3/8" (FOURNIS)
- 6) INSTALLEZ LA BOITE DE JONCTION A LA PLAQUE DE MONAGE AVEC DES ÉCROUS (2)8-32
- 7) (2) ÉCROUS 8-32 (FOURNIS)
- 8) RACCORDEZ CES FILS AUX FILS CONDUCTEUR ET AUX FILS DE LAMPES
- 9) UNISSEZ LE BALLAST À LA BOITE DE JONCTION

Fulham Co., Inc extends limited warranty only to the original purchaser or to the first user for the period of 3 years @ 90° C & 5 years @ 70° C from the date of manufacture as indicated by the date code stamped on each product and when properly installed and under normal conditions of use. For additional warranty guide line, please refer to our Complete Product Catalog OR call Customer Service at 1-323-599-5001.

DUE TO A PROGRAM OF CONTINUOUS IMPROVEMENT, FULHAM Co., INC RESERVES THE RIGHT TO MAKE ANY VARIATION IN DESIGN OR CONSTRUCTION TO THE EQUIPMENT DESCRIBED.

Address : 12705 South Van Ness Ave., Hawthorne, CA 90250 Tel.: 1-323-599-5001, Fax.: 1-323-754-9060. Website: www.fulham.com

2013-391-1 rev

SPECIFICATION SHEET : RHA-UNV-218-C

This Is An Original Product From Fulham Co., Inc

Description : RACEHORSE Series, Universal Operating Voltage, Programmed Start Ballast, End Of Life Protection, Auto Restart, Cold Starting Feature.

This Ballast Will Operate Following Lamps.

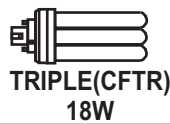
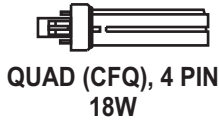

ELECTRICAL DATA (With 120 Volt Application)

INPUT VOLT: 120V ± 10% , 50/60Hz								
LAMP WATTS/TYPE	CFQ18	CFTR18	2D21	CFQ18	CFTR18	2D21	2D16	
LAMPS OPERATED	1			2				
INPUT WATTS	21	19	21	40	33	38	38	
LINE CURRENT:	0.17	0.16	0.23	0.33	0.30	0.32	0.32	
POWER FACTOR	0.99	0.99	0.99	0.99	0.99	0.99	0.99	
BALLAST FACTOR	1.12	1.12	1.06	1.04	1.05	0.98	1.18	
EFFICACY FACTOR	5.43	5.99	5.06	2.60	3.21	2.56	3.07	
THD	< 10%							
CURRENT CREST FACTOR	< 1.7							
EMI/RFI COMPLIANCE	FCC PART 18-A (NON-CONSUMER)							
SOUND RATING	" A "							
BALLAST TYPE	PROGRAMMED START							
VOLTAGE TRANSIENTS	MOV (ANSI C82.11)							
INPUT/PROTECTION	FUSE							
OUTPUT/PROTECTION	OPEN LAMP, SHORTED LAMP, END-OF-LIFE							
MIN. OPERATING TEMP	-30°C (-22°F)							
MAX. CASE TEMP	90°C (194°F) SEE FOOT NOTE WARRANTY							
APPROVALS/CLASS	UL /cUL LISTED, CLASS " P ", 1 OUTDOOR							
REMOTE MOUNTING	18 FT MAX.							

MECHANICAL DATA

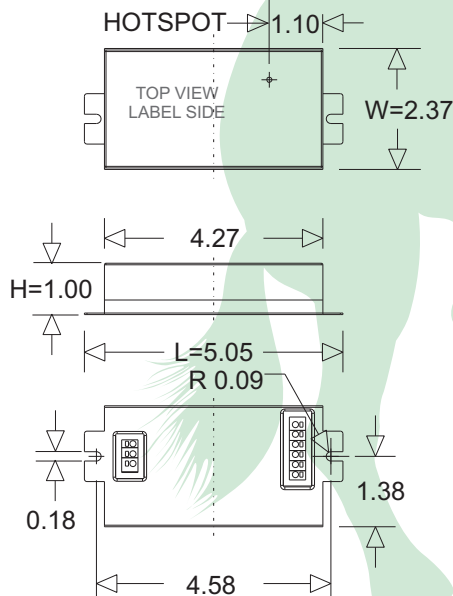

Where : L = Length, W = Width, H = Height

WIRING DIAGRAMS

1 X CFQ18W, CFTR18W, 2D21W

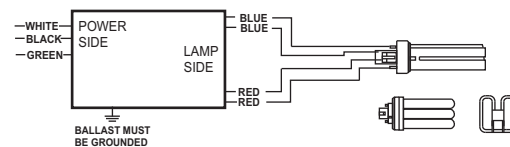

2 X CFQ18W, CFTR18W, 2D16/21W

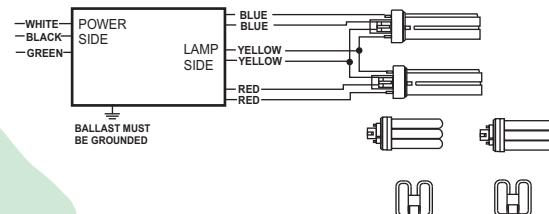

NOTE : This Ballast Must Be Grounded

Fulham extends a limited warranty only to the original purchaser or to the first user for a period of 5 years @ 75°C or 3 years @ 90°C from the date of manufacture when properly installed and operated under normal conditions of use. For complete terms and conditions, please reference the Fulham product catalog (www.fulham.com) Due to a program of continuous improvement, Fulham reserves the right to make modifications or variations in design or construction to the equipment described.

SPECIFICATION SHEET : RHA-UNV-218-C

This Is An Original Product From Fulham Co., Inc

Description : RACEHORSE Series, Universal Operating Voltage, Programmed Start Ballast, End Of Life Protection, Auto Restart, Cold Starting Feature.

This Ballast Will Operate Following Lamps.

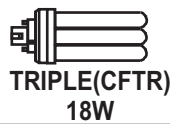
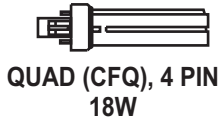

ELECTRICAL DATA (With 277 Volt Application)

INPUT VOLT: 277V ± 10%, 50/60Hz								
LAMP WATTS/TYPE	CFQ18	CFTR18	2D21	CFQ18	CFTR18	2D21	2D16	
LAMPS OPERATED	1			2				
INPUT WATTS	20	18	21	40	35	38	37	
LINE CURRENT:	0.08	0.07	0.08	0.15	0.13	0.14	0.11	
POWER FACTOR	0.95	0.94	0.95	0.98	0.98	0.98	0.98	
BALLAST FACTOR	1.12	1.12	1.06	1.04	1.05	0.97	1.19	
EFFICACY FACTOR	5.48	6.04	4.96	2.62	3.00	2.57	3.22	
THD	< 10%							
CURRENT CREST FACTOR	< 1.7							
EMI/RFI COMPLIANCE	FCC PART 18-A (NON-CONSUMER)							
SOUND RATING	" A "							
BALLAST TYPE	PROGRAMMED START							
VOLTAGE TRANSIENTS	MOV (ANSI C82.11)							
INPUT/PROTECTION	FUSE							
OUTPUT/PROTECTION	OPEN LAMP, SHORTED LAMP, END-OF-LIFE							
MIN. OPERATING TEMP	-30°C (-22°F)							
MAX. CASE TEMP	90°C (194°F) SEE FOOT NOTE WARRANTY							
APPROVALS/CLASS	UL /cUL LISTED, CLASS " P ", 1 OUTDOOR							
REMOTE MOUNTING	18 FT MAX.							

MECHANICAL DATA

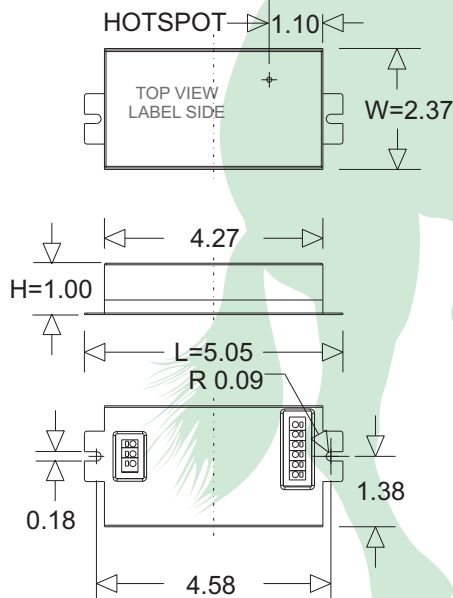

WIRING DIAGRAMS

1 X CFQ18W, CFTR18W, 2D21W

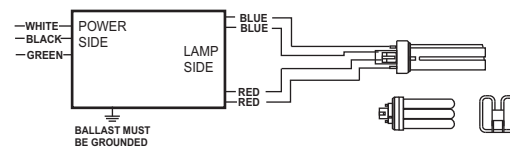

2 X CFQ18W, CFTR18W, 2D16/21W

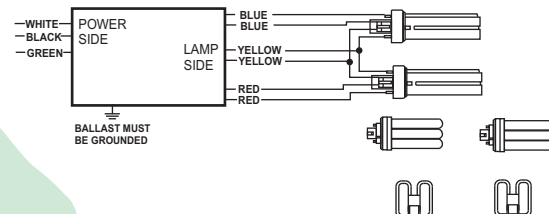

NOTE : This Ballast Must Be Grounded

Fulham extends a limited warranty only to the original purchaser or to the first user for a period of 5 years @ 75°C or 3 years @ 90°C from the date of manufacture when properly installed and operated under normal conditions of use. For complete terms and conditions, please reference the Fulham product catalog (www.fulham.com) Due to a program of continuous improvement, Fulham reserves the right to make modifications or variations in design or construction to the equipment described.