



MR16 LED

10MR16/END/F24 2700 DIM 10/1

Philips MR16 Dimmable LED Lamps provide ambient level light to illuminate hard to maintain applications. Increased transformer compatibility allows for operation on a wider range of transformers. Available in dimmable and non-dimmable versions, these lamps are ideal for track and open recessed fixtures in retail, hospitality and residential spaces.

Product data

• General Characteristics

Cap-Base	GU5.3
Bulb	MR16 [MR 16inch/50mm]
Rated Avg. Life (Hours)	25000 hr

• Light Technical Characteristics

Color Code	WW
Color Designation	Warm White
Beam Angle	24 D
Beam Description	- [-]
Correlated Color Temperature	2700 K
Approx. MBCP	1970 cd
CRI	80
Color Temp. (Kelvin)	2700 K [CCT 2700K]
Rated Luminous Flux	480 Lm

• Electrical Characteristics

Wattage	10 W
Wattage Technical	10 W

Voltage	12 V
Power Factor	0.8 -
Lamp Current mA	1078 mA
Dimmable	Yes
Starting Time	0.5 (max) s

• Product Dimensions

Overall Length C	50.2 mm
Diameter D	50 mm

• Product Data

Product number	420166
Full product name	10MR16/END/F24 2700 DIM 10/1
Short product name	10MR16/END/F24 2700 DIM 10/1
Pieces per Sku	1
eop_pck_cfg	10
Skus/Case	10
Bar code on pack	46677420161
Bar code on case	50046677420166
Logistics code(s)	929000219304
eop_net_weight_pp	0.035 kg

Dimensional drawing



PHILIPS

Dimensional drawing

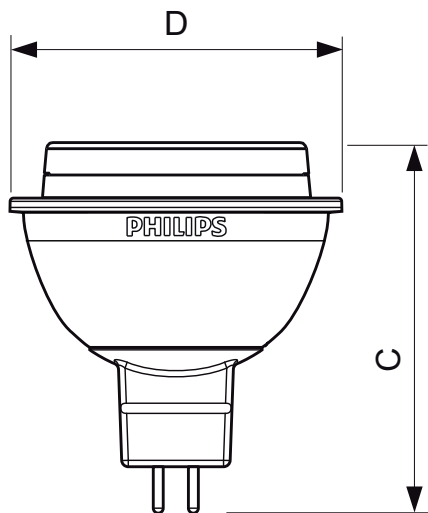

10MR16/END/F24 2700 DIM 10/1

Product	C (Norm)	D (Norm)
LED 10W 2700K 12V 24D	50.2	50

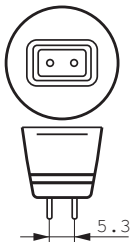

GU5.3



© 2013 Koninklijke Philips N.V. (Royal Philips)
All rights reserved.

Specifications are subject to change without notice. Trademarks are the property of Koninklijke Philips N.V. (Royal Philips) or their respective owners.

www.philips.com/lighting

2013, June 21
data subject to change