



PAR38

Dimmable Recessed Light

Leapfrog Lighting's PAR38 LED lamp provides industry-leading light quality, output power, and efficacy as a result of our patented intelligent optics lens and high-efficiency, high-reliability LED source and driver electronics.

Features

- Innovative anti-glare lens technology
- Available in a variety of CCTs and beam angles
- Special high CRI models
- Top performing light output and efficacy
- High Power Factor
- Compatible with most ANSI/NEMA approved dimmers designed for LED use
- UL certified
- Comprehensive five-year warranty
- Tested per IESNA LM-79-2008



Contact

Head Office
400 March Road
Ottawa ON Canada
K2K 3H4
613-270-7879

North America (toll free):
1-800-396-9109

sales@leapfroglighting.com
www.leapfroglighting.com

LIGHT QUALITY

Evenly distributed, glare-free light with gentle roll-off at edges

APPLICATIONS

Indoor and unexposed outdoor down-lighting applications

LIFE EXPECTANCY

40,000 hours

SPECIFICATIONS

CCT ¹	CRI ²	BEAM	LM	W	LM/W	PART
2700K	82	20°	1150	16.4	68	1001-P38LC-2703
	82	38°	1150	16.4	68	1001-P38LC-2701
	82	60°	1150	16.4	68	1001-P38LC-2702
	95	20°	900	16.4	53	1001-P38LC-2706
	95	38°	900	16.4	53	1001-P38LC-2704
3000K	95	60°	900	16.4	53	1001-P38LC-2705
	82	20°	1150	16.4	68	1001-P38LC-3005
	82	38°	1150	16.4	68	1001-P38LC-3001
	82	60°	1150	16.4	68	1001-P38LC-3003
	95	20°	900	16.4	53	1001-P38LC-3006
5000K	95	38°	900	16.4	53	1001-P38LC-3002
	95	60°	900	16.4	53	1001-P38LC-3012
	82	20°	1225	16.7	72	1001-P38LC-5003
	82	38°	1225	16.7	72	1001-P38LC-5001
	82	60°	1225	16.7	72	1001-P38LC-5002
5000K	95	20°	1050	16.7	62	1001-P38LC-5006
	95	38°	1050	16.7	62	1001-P38LC-5004
	95	60°	1050	16.7	62	1001-P38LC-5005

1. Tolerances as per ANSI C78.377-2008 Nominal CCT categories
2. CRI refers to the "General CRI" described as Ra in CIE 13.3

PERFORMANCE

Dimmable, high efficacy (lm/W), single light source

COLOR

Ultra-consistent color temperature control critical to multi-lamp applications, with high CRI and pleasing CCT options.

GENERAL

Min. lifetime ³	40,000 hours
Base type	E26/E27
Weight	1lb 8 oz.
Dimensions ⁴	PAR38L

ELECTRICAL

Voltage, nominal	120 VAC
Power factor	> 0.95
Dimming range	Flicker free down to 10% light output

OPTICAL

Duv ⁵	< 0.006
------------------	---------

3. Lifetime as defined by IESNA LM-80
4. Compatible with ANSI C78.21-2011 dimensional requirements
5. Duv values and tolerances as per ANSI C78.377-2008 Nominal CCT, Table 1, page 8

BASE TYPE

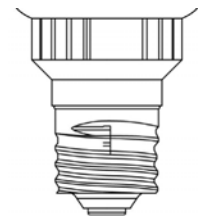

E26/27

PAR38 DIMMER COMPATIBILITY (North America)

COOPER	LEGRAND	LEVITON	LUTRON
Aspire 9570 120V - 60Hz - 300W 9573 120V - 60Hz - 300W	Harmony DCL453PTC 120V - 60Hz - 450W	RPl06-1L/RPl06-1o 120V - 60Hz - 600W	Ariadni AYCL-153PH 120V - 60Hz - 600W TGCL-153PH 120V - 60Hz - 600W
Devine DEL06P 120V - 60Hz - 300W		S-600PH-WH-CSA 120V - 60Hz - 600W	Cradenza TT300 120V - 60Hz - 300W
Devione DLC03P 120V - 60Hz - 300W		6631-I 120V - 60Hz - 600W	Diva DVCL-153P* 120V - 60Hz - 600W
Skype SEL06P 120V - 60Hz - 300W SLC03P 120V - 60Hz - 300W			Lumea LGCL-153PLH 120V - 60Hz - 600W
			Maestro MACL-153M* 120V - 60Hz - 600W
			Skylark CTCL-153P* 120V - 60Hz - 600W

POLAR INTENSITY DIAGRAMS

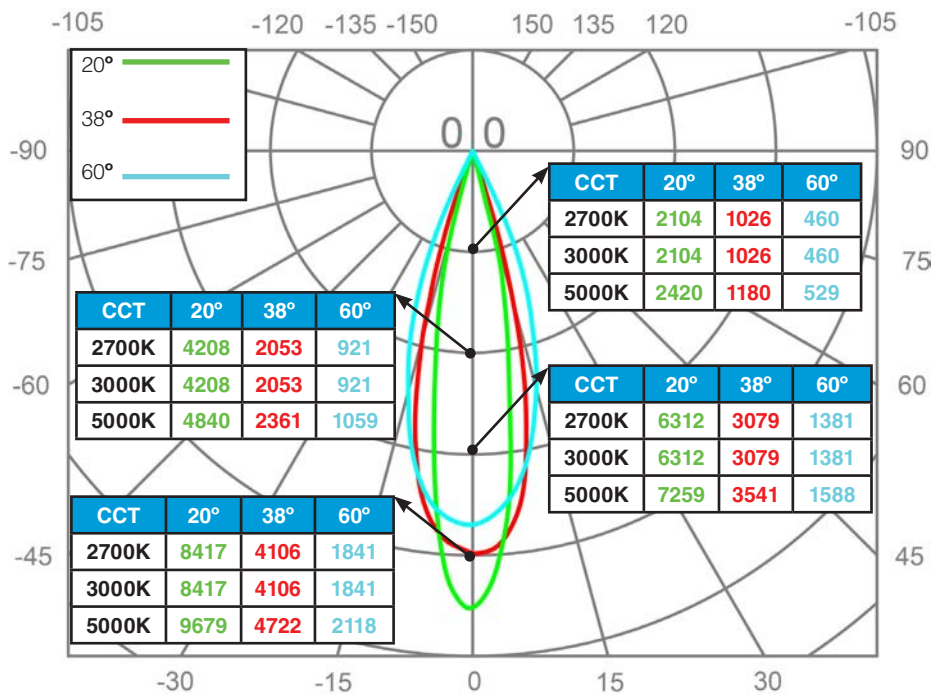

DIMENSIONS

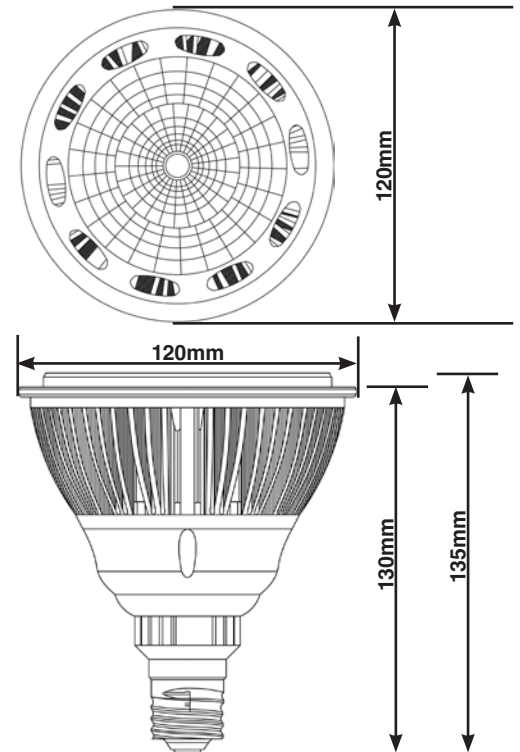

SPECTRAL POWER DISTRIBUTION

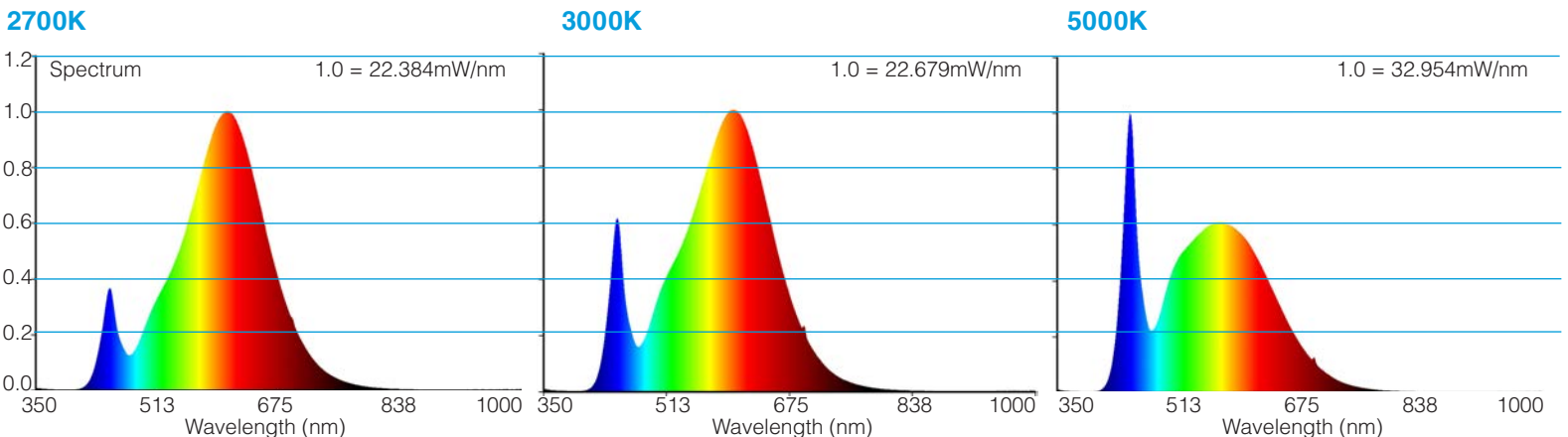

BEAM ANGLES

2700K

20 degrees

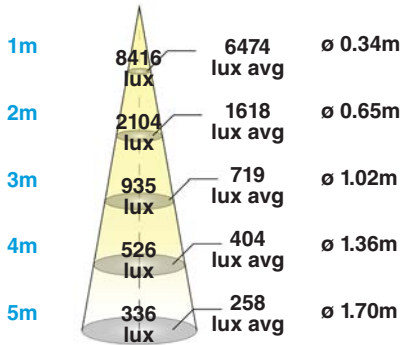

38 degrees

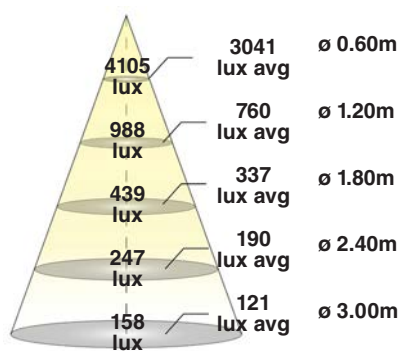

60 degrees

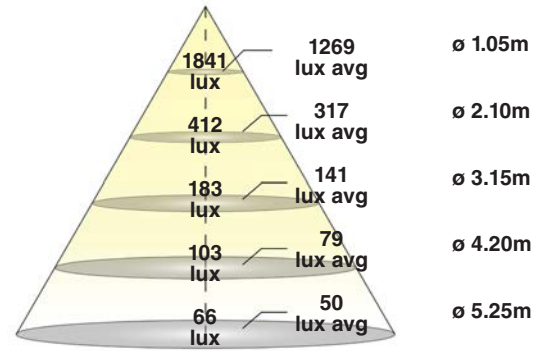

3000K

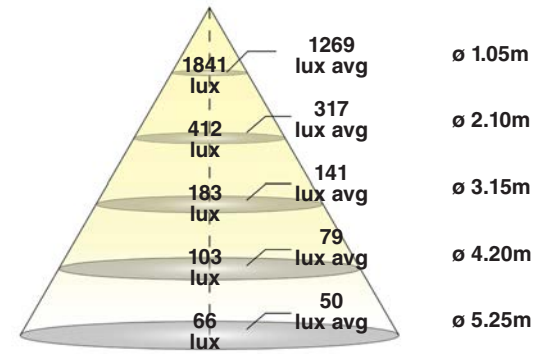
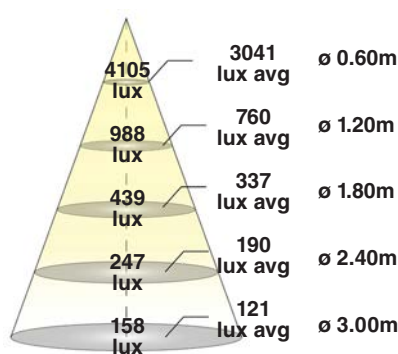
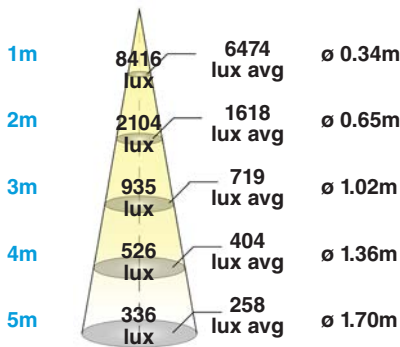

5000K

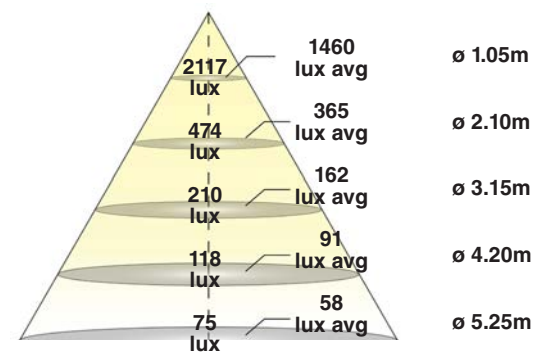
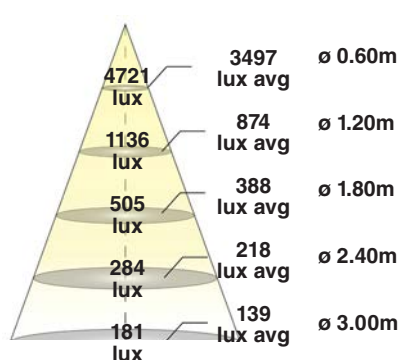
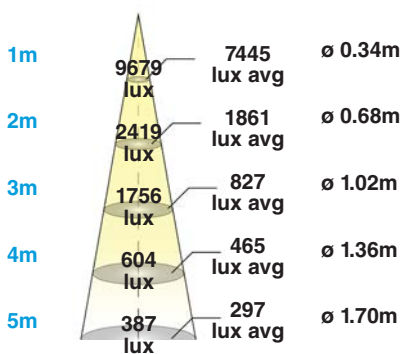

WARRANTY

If you're not satisfied with this lamp within 3 months, we will refund the purchase price. If the lamp fails to meet our specifications during the first 60 months, we'll replace it. For additional warranty information, please refer to: <http://www.leapfroglighting.com/resources/>.

APPLICATION NOTES

Not for use in exposed outdoor down-lighting applications

Ambient temperature within -20 to +45 °C

SAFETY NOTES

Warning: Risk of electric shock

Do not disassemble (no user serviceable parts)

Turn off power before inspection, installation or removal.

