

SORAA® VIVID LED MR16 3000K 12VAC



Narrow Flood and Flood



Spot



POWERED BY GaN on GaN TECHNOLOGY

Soraa's VIVID LED MR16 is the leader in next-generation high CRI LED lamps. The VIVID lamp's unprecedented perfect spectrum light, CRI of 95, R9 of 95, rich saturated color rendering, bright white rendering, and excellent color stability makes it the only choice for demanding display applications. Powered by Soraa's GaN on GaN™ technology, VIVID lamps match or exceed halogen MR16 performance, in color, output, energy efficiency, and ROI. VIVID lamps are revolutionizing lighting design, and with their unique single source optics deliver the best color and white rendering, beam definition, and crisp shadows available in directional light sources

PERFORMANCE

CBCP matches standard halogen lamps
Single light source
Single crisp shadow
Dimmable to 20%
Power Factor: 0.93
12V (10.8 min, 13.2 max)

COLOR

CCT: 3000K
CRI>95, R9 95
White point accuracy within 3 SDCM
Rich saturated color rendering
Excellent color stability

OPTIMIZED FORM

ANSI standard MR16 form factor:
1.96" (50mm) W x 1.86" (47.6mm) H
Compatible with standard fixtures
Weight: 40g
Proprietary fanless aluminum design provides superior thermal dissipation

HIGHLY COMPATIBLE

Works with magnetic and electronic transformers and dimmers (see complete list at www.soraa.com)
UL and CUL listed for use with 12VAC NEC Class 1 and Class 2 systems

LONG LIFE, LOW MAINTENANCE

Life of 35,000 hours
Three year warranty

ENERGY EFFICIENT

Saves over 75-80% of energy compared to standard halogen lamps
Typical payback of one year or less

INTENDED USE AND APPLICATIONS

LED retrofit lamp to replace 12VAC halogen MR16 lamps in recessed downlights, track lighting, and other indoor applications
For use in recessed downlights, track lighting and other indoor applications. Not for use with glass lenses or fully sealed fixtures
Not for use in non-ventilated fixtures less than 3"L x 3"W x 3"H.
Not for use in Emergency Fixtures or Exit Signs
Operating Temperature: Minimum -40°C (ambient); Typical: 80-110°C (base); Maximum: 120°C (base)
Soraa lamps are designed to safely shut down due to conditions in any thermal environment not conducive to minimum airflow or proper ventilation

CERTIFICATIONS

UL, CUL for 12VAC NEC Class 1 and Class 2 systems, FCC 47 CFR Part 15 and Part 18 (EMI), RoHS, CE, C-tick



SPECIFICATIONS*

Reference Number	Product Code	Beam	Field	CBCP	Watts	Halogen Equivalent
MR16-40-B01-12-930-14	00133	14°	27°	3250	10.4	35w
MR16-50-B01-12-930-20	00061	20°	38°	2100	12.2	40w
MR16-50-B01-12-930-25	00085	25°	42°	1900	12.2	40w
MR16-50-B01-12-930-36	00109	36°	60°	1075	12.2	40w

*at stable warm operating conditions (25°C ambient)

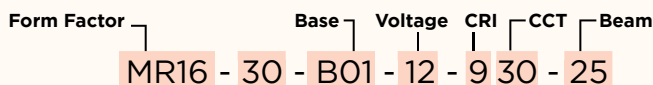

The diagram at left shows how to read the different components of the reference number. Base type B01 refers to the GU 5.3 base.

SORAA VIVID LED MR16 3000K 12VAC

PHOTOMETRICS

Spot - 14°

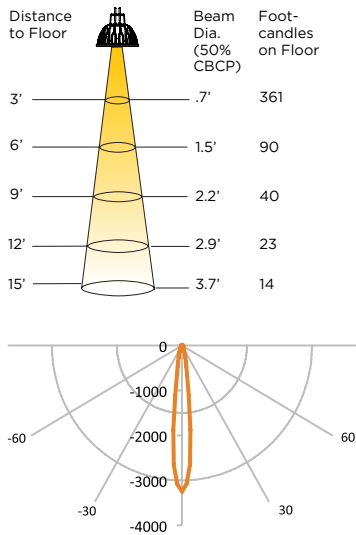

Narrow Flood -20°

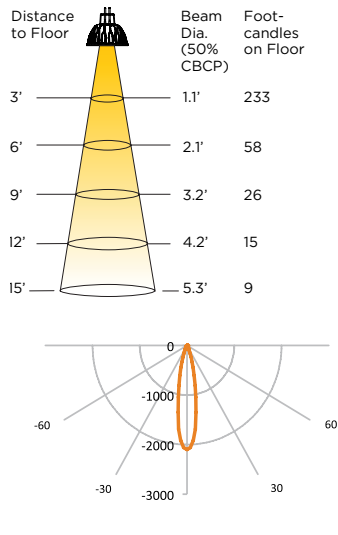

Narrow Flood -25°

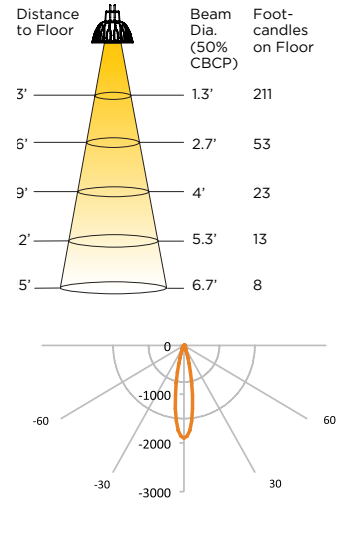

Flood -36° Degree

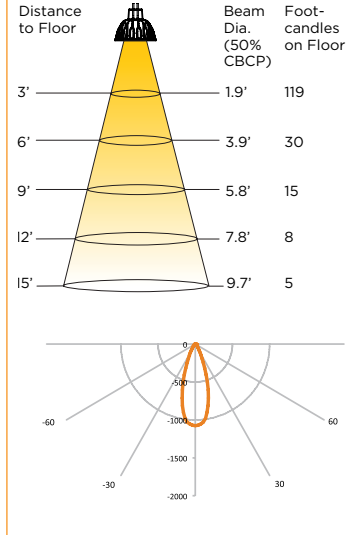

COLOR RENDERING

CRI- Relative R Values

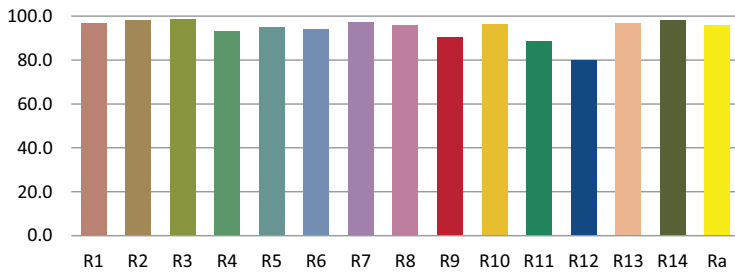

Comparative Spectra

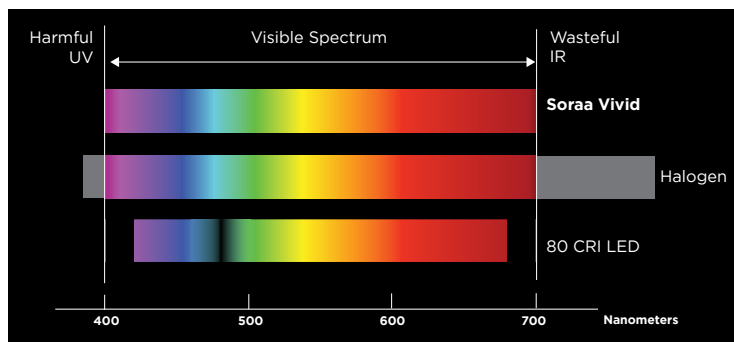

DIMENSIONS

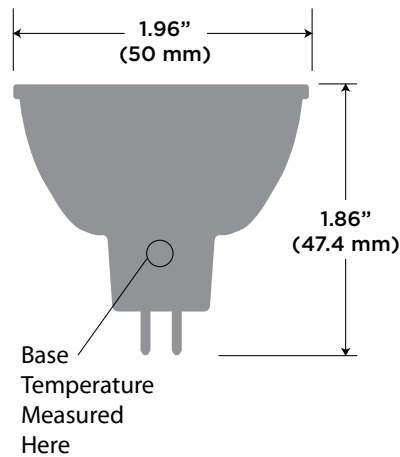

SAFETY NOTE ON HEAT

Soraa's unique LED technology allows its lamps to operate effectively and efficiently at higher temperatures than other LED lamps, resulting in more light output per diode. Although Soraa's lamps operate at cooler temperatures than halogen lamps, it is recommended that gloves be worn when handling bare lamps that have been energized.

TRANSFORMER/DIMMER COMPATIBILITY

Dimmable to 20% or lower, depending on dimmer. Complete transformer and dimmer compatibility information at www.soraa.com.