

# MLSWP30LED50DS



## LED WALLMAX - SMALL 30W WALL PACK: FULL CUTOFF

DLC Qualified Wall Pack meets full cut off criteria established by the IESNA.

**LED Module:** An efficient, energy saving replacement for metal halide and high-pressure sodium fixtures. Contains an integral listed Driver.

Fixture can mount to electrical box or direct to surface.

### FEATURES:

- Replaces up to 150 Watt Metal Halide
- DLC qualified
- Lumens delivered 2400
- 34 Watts total consumed
- CCT 5000K
- 50,000 hour life at L70 standards
- Self-contained potted driver
- Universal 120V through 277V
- Maintenance free; no UV; no lead; no mercury
- Dusk To Dawn / Occupancy sensor compatible
- Can mount on electrical box or direct to surface
- LM-79/80 data available
- 5 Year Limited Warranty
- 20W, 40W, and 60W models available
- Does not attract insects

PROJECT NAME
CATALOG NUMBER
NOTES
FIXTURE TYPE



### CONSTRUCTION:

**Fixture:** Heavy-duty cast aluminum one-piece housing; polyester coated; rust and corrosion proof. Fixture is sealed to be dirt and bug proof.

**Lens:** High quality anti-shock Boron glass.

**LED Module:** Copper plating to provide high thermal transfer rate minimizing junction temperature of LED.

**Finish:** Dark Bronze or Textured White



#### Luminaire Ordering Information:

WATTS	ORDER CODE	MODEL NUMBER	LUMENS	L70 LIFE (Hrs)	DIMENSIONS (L"xW"xH")	K
30	70880	MLSWP30LED50DS	2400	50,000	12.6 x 11.26 x 9.0	5000
30	71130	MLSWP30LED50DSW	2400	50,000	12.6 x 11.26 x 9.0	5000

MAX11337-101-10

Lighting layouts and spacing criteria available upon request

\*Caution: This fixture is DLC compliant and designed for downward illumination only.

## SPECIFICATIONS:

Item	Specification	Details
<b>General Performance</b>	Spacing Criteria	Available upon request
	Color Temperature	5000K
	Lumens	2400
	Efficacy	69 lumen/watt
	Color Consistency	Proprietary binning for uniform color
	Lumen Maintenance (L70)	50,000 hours
<b>Electrical</b>	Power Factor	Over 98%
	Input Voltage	120V-277V 50/60 Hz
	Power Consumption	34.8 Watts
<b>Physical</b>	Dimensions	12.6" x 11.26" x 9.0"
	Weight	6.15 lbs
	Housing	Aluminum
	Lens	Anti-Shock Boron Glass
	Mounting	Fits electrical box or mount direction surface
	Operating Temperature	-30°F to 130°F
	Humidity	20% - 85% RH, non condensing
<b>Certification</b>	Certification	ETL, FCC, DLC, NEEP, LM79, LM80
	Material Usage	RoHS compliant; no mercury
	Environment	Indoor / Outdoor
	LED Class	N/A

Lighting layouts and spacing criteria available upon request

## DIMENSIONS:

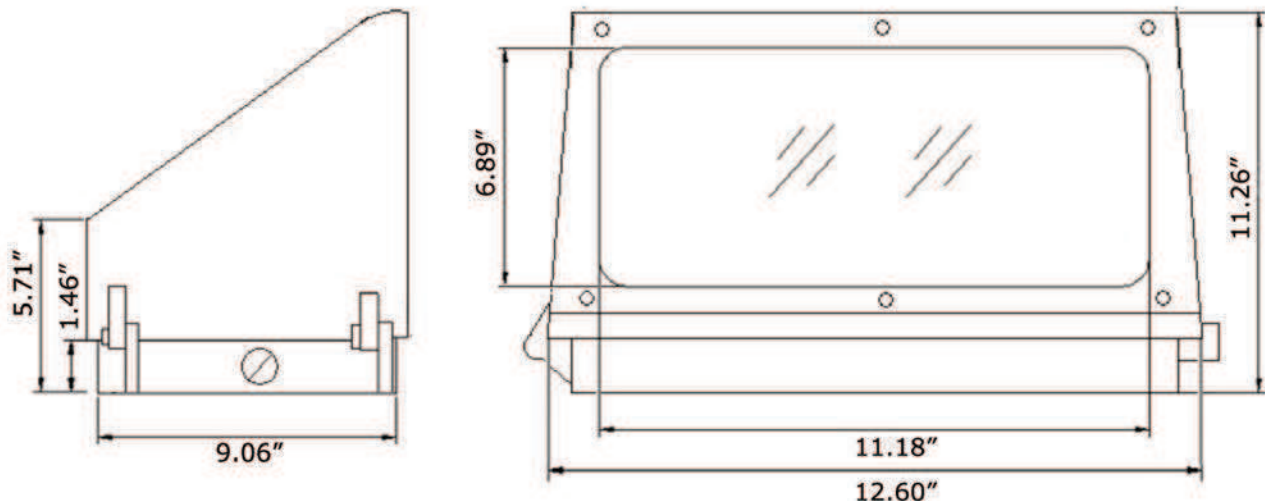

**PHOTOMETRICS:**

MAXIMUM PLANE AND MAXIMUM CONE PLOTS OF CANDELA

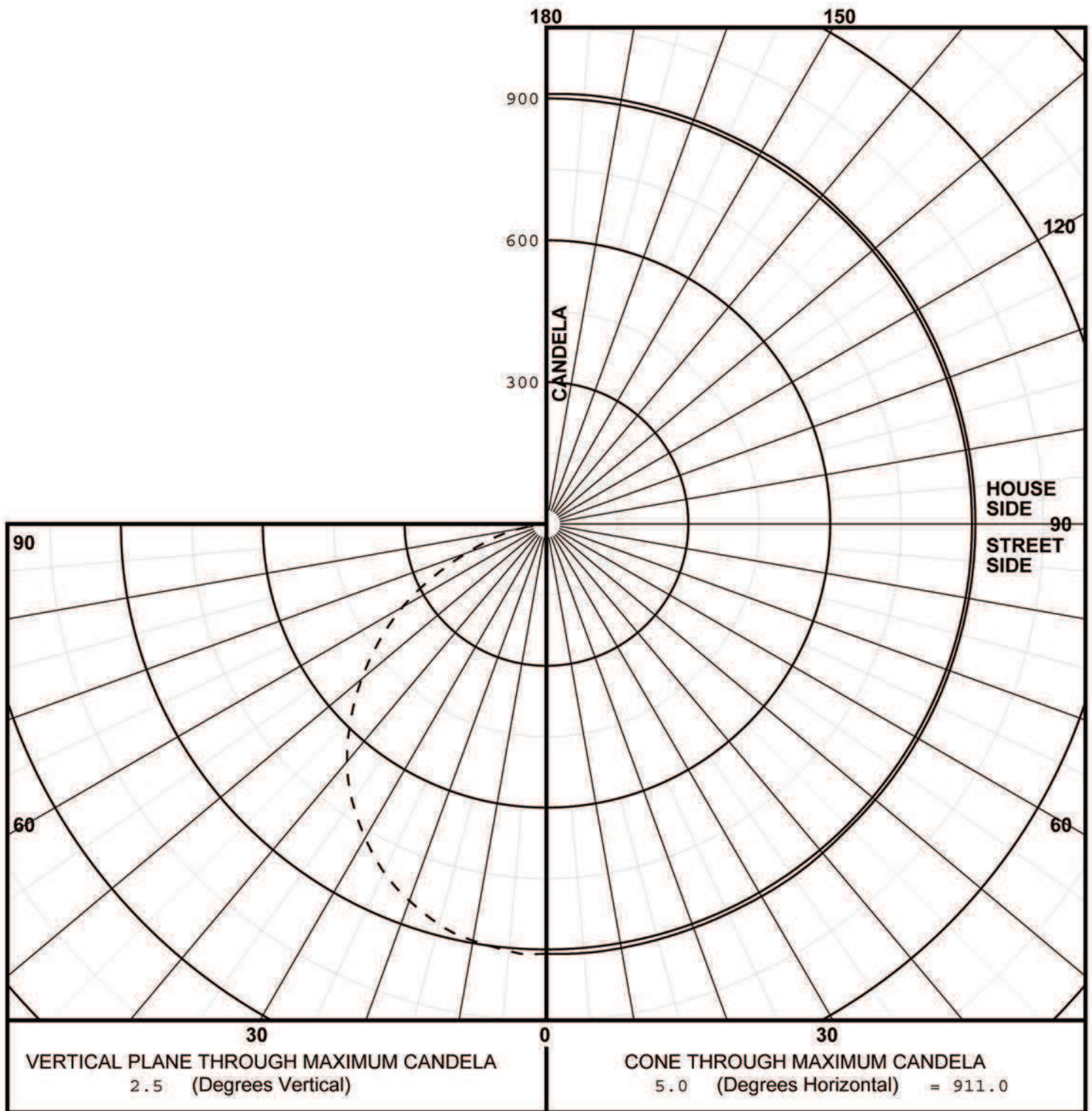

Lighting layouts and spacing criteria available upon request