

## Hi-lume® 3D Overview

Hi-lume® 3D architectural electronic dimming ballasts are designed to meet the most demanding lighting requirements. By providing industry leading performance with a full-range of 100% to less than 1% fluorescent dimming, Hi-lume® 3D ballasts enable you to provide the ideal visual environment for any application.

### Features

- Continuous, flicker-free dimming from 100% to 0.7% for T8, 1% for T5 and T5HO, and 5% for T5 twin-tube.
- 100% compatible with all Lutron® 3-wire fluorescent controls and EcoSystem® digital controls for consistent fixture-to-fixture dimming performance.
- Compatible with Energi Savr Node™ with EcoSystem® devices, GRAFIK Eye® QS control unit, PowPak® dimming module with EcoSystem® connection, and Quantum® software, allowing for integration into an existing or planned EcoSystem® lighting control solution.
- Programmed rapid-start design preheats lamp cathodes before applying full arc voltage to ensure full-rated lamp life while dimming and cycling.
- Lamps turn on to any dimmed level without going to full brightness.
- Low harmonic distortion throughout the entire dimming range maintains power quality.
- Frequency of operation ensures that ballast does not interfere with infrared devices operating between 38 kHz and 42 kHz.
- Inrush current limiting circuitry eliminates circuit breaker tripping, switch arcing, and relay failure.
- Ballasts maintain consistent light output for different lamp lengths, ensuring fixture-to-fixture uniformity.
- Ultra-quiet operation.
- Ballast protected from miswires of any input power to control lead, or from lamp leads to each other and/or ground.



**Hi-lume® 3D, case type C**  
 1.18 in (30 mm) W × 1.00 in (25 mm) H ×  
 18.00 in (457 mm) L



**Hi-lume® 3D, case type G**  
 2.38 in (60 mm) W × 1.00 in (25 mm) H ×  
 9.50 in (241 mm) L

- 100% performance-tested and burned-in at factory.
- Non-volatile memory restores all ballast settings after power failure.
- Buy American Act (BAA) models available; see Model List for specific availability.
- RoHS compliant.
- NOM certified models available; see Model List for specific availability.
- Custom ballast factors available for UL® or CSA-listed products. Design tool and specifications can be found at [www.lutron.com/ballasttool](http://www.lutron.com/ballasttool).

<p><b>Job Name:</b></p> <p><b>Job Number:</b></p>	<p><b>Model Numbers:</b></p>
--	------------------------------

## Specifications

### Regulatory Approvals

- California Energy Commission Listed\*
- UL-listed (evaluated to the requirements of UL935)
- CSA certified (evaluated to the requirements of C22.2 No. 74) (specific model numbers only)
- Class P thermally protected
- Meets ANSI C82.11 High Frequency Ballast Standard
- Meets FCC Part 18 Non-Consumer requirements for EMI/RFI emissions
- Meets ANSI C62.41 Category A surge protection standards up to and including 4 kV
- Manufacturing facilities employ ESD reduction practices that comply with the requirements of ANSI/ESD S20.20
- Lutron® Quality Systems registered to ISO9001.2008

### Environment

- Minimum lamp starting temperature: 50 °F (10 °C)
- Relative humidity: less than 90% non-condensing
- Sound Rating: Class A
- Maximum ballast case temperature: 75 °C

### Ballast Wiring and Mounting

- Ballast is grounded via a mounting screw to the fixture
- Ballast mounts using two screws (or sheet metal feature and one screw) within a fluorescent fixture.
- Power and lamp wiring terminals accept one 18 to 16 AWG (0.75 to 1.5 mm<sup>2</sup>) solid copper wire per terminal.

### Lamp Seasoning

- Refer to the lamp manufacturer's requirements for lamp seasoning requirements prior to dimming.

### Warranty

- 5-year limited warranty with Lutron® field service commissioning (3-year standard warranty) from date of purchase. For additional Warranty information, please visit:  
[www.lutron.com/TechnicalDocumentLibrary/Ballast%20and%20Driver%20Warranty.pdf](http://www.lutron.com/TechnicalDocumentLibrary/Ballast%20and%20Driver%20Warranty.pdf)

### Performance

- Dimming Range: 100% to 0.7% measured relative light output (RLO) for T8, 100% to 1% measured RLO for T5 and T5HO, and 100% to 5% measured RLO for T5 twin-tube.
- Lamp Starting: programmed rapid-start
- Lamp Current Crest Factor: less than 1.7
- Lamp Flicker: none visible
- Light Output Variation: constant ±2% light output for line voltage variations of ±10%
- Lamp Life: average lamp life meets or exceeds rating of lamp manufacturer
- Power Factor: greater than 0.95
- Typical Total Harmonic Distortion (THD) less than 10%\*\*
- Maximum Inrush Current: 7 A per ballast at 120 V~, 3 A per ballast at 277 V~
- Operating Voltage: Universal input 120, 220/240, 277 V~ at 50/60 Hz
- Frequency of Operation: greater than 42 KHz
- Ballast Factor (BF): 1.0/1.17 for T8 lamps and 1.0 for T5, T5HO, and T5 twin-tube lamps

Dimming Range for T5 and T5HO lamps:

BF	Dimming Range (Max/Min [BF])	Dimming Ratio
1.0	1.00 / 0.01	100:1

Dimming Range for T8 lamps:

BF	Dimming Range (Max/Min [BF])	Dimming Ratio
1.17	1.17 / 0.0085	138:1
1.0	1.00 / 0.0085	118:1

Dimming Range for T5 Twin Tube lamps:

BF	Dimming Range (Max/Min [BF])	Dimming Ratio
1.0	1.00 / 0.05	100:5

\* Not required for T5 twin tube models.

\*\* Typical THD for models H3DT817CU110, H3DT514CU110 and H3DT521CU110 less than 15%.

<b>Job Name:</b>	<b>Model Numbers:</b>
<b>Job Number:</b>	

## Hi-lume® 3D Ballasts for Linear and U-Bent T8 Lamps

For proper dimming, all lamps must comply with accepted standards: 17, 25, 32, 40 W (NEMA LL9-2009)

Not for use with reduced-wattage lamps.

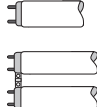
Lamp Type	Lamp Watts (length)	Lamps per Ballast	Case Size	Hi-lume® 3D Model Number	Input Voltage (V~)	Ballast Current (A)	Ballast Factor (BF)	Input Power (W)	System Lumens <sup>3</sup> (lm)	System Efficacy <sup>3</sup> (lm/W)	Ballast Efficacy Factor (BEF)	Relative System Efficacy (RSE)
	40 W (60 in [1524 mm])	1	C	H3D T840 C U 1 10	120 240 277	0.38 0.18 0.16	1.00 1.00 1.00	43.8 43.0 42.8	3800 3800 3800	87 88 89	2.28 2.33 2.34	0.91 0.93 0.94
		1	C	H3D T840 C U 1 17	120 240 277	0.42 0.21 0.18	1.17 1.17 1.17	50.6 49.4 49.6	4446 4446 4446	88 90 90	2.31 2.37 2.36	0.92 0.95 0.92
		2	C	H3D T840 C U 2 10	120 240 277	0.76 0.37 0.32	1.00 1.00 1.00	90.9 88.4 88.9	7600 7600 7600	84 86 86	1.10 1.13 1.13	0.90 0.91 0.94
		2	C	H3D T840 C U 2 17	120 240 277	0.85 0.41 0.36	1.17 1.17 1.17	100.3 97.2 98.2	8892 8892 8892	89 92 91	1.17 1.20 1.19	0.93 0.96 0.95
	32 W (48 in [1219 mm])	1	C	H3D T832 C U 1 10 <sup>1,2</sup>	120 240 277	0.29 0.14 0.12	1.00 1.00 1.00	34.8 33.6 33.2	3000 3000 3000	86 89 90	2.87 2.98 3.01	0.92 0.95 0.96
			G	H3D T832 G U 1 10 <sup>1,2</sup>	120 240 277	0.30 0.15 0.13	1.00 1.00 1.00	34.8 35.0 35.1	3000 3000 3000	86 86 85	2.87 2.85 2.85	0.92 0.91 0.91
		1	C	H3D T832 C U 1 17 <sup>1,2</sup>	120 240 277	0.34 0.17 0.15	1.17 1.17 1.17	40.8 40.8 41.6	3510 3510 3510	86 86 84	2.87 2.87 2.82	0.92 0.92 0.90
			G	H3D T832 G U 1 17 <sup>1</sup>	120 240 277	0.34 0.17 0.15	1.17 1.17 1.17	39.7 40.0 40.1	3510 3510 3510	88 88 88	2.95 2.92 2.92	0.94 0.94 0.93
		2	C	H3D T832 C U 2 10 <sup>1,2</sup>	120 240 277	0.57 0.28 0.24	1.00 1.00 1.00	68.4 67.2 66.5	6000 6000 6000	88 89 90	1.46 1.49 1.50	0.94 0.95 0.96
			G	H3D T832 G U 2 10 <sup>1,2</sup>	120 240 277	0.58 0.28 0.24	1.00 1.00 1.00	68.9 66.3 66.5	6000 6000 6000	91 90 90	1.52 1.51 1.50	0.97 0.97 0.96
		2	C	H3D T832 C U 2 17 <sup>1,2</sup>	120 240 277	0.65 0.32 0.28	1.17 1.17 1.17	78.0 76.8 77.6	7020 7020 7020	90 91 91	1.50 1.52 1.51	0.96 0.98 0.97
			G	H3D T832 G U 2 17 <sup>1</sup>	120 240 277	0.67 0.31 0.28	1.17 1.17 1.17	75.4 76.5 76.9	7020 7020 7020	93 92 91	1.55 1.53 1.52	0.99 0.98 0.97
		3	G	H3D T832 G U 3 10 <sup>1,2</sup>	120 240 277	0.83 0.40 0.37	1.00 1.00 1.00	99.6 96.0 102.5	9000 9000 9000	90 94 88	1.00 1.04 0.98	0.96 1.00 0.94
		3	G	H3D T832 G U 3 17 <sup>1</sup>	120 240 277	0.95 0.47 0.41	1.17 1.17 1.17	114.0 112.8 113.6	10,530 10,530 10,530	92 93 93	1.03 1.04 1.03	0.99 1.00 0.99

(Continued on next page)

### Notes

- <sup>1</sup> BAA models available. Add a "U" to prefix of model number when ordering (e.g., **UH3D T832 C U 1 10**).
- <sup>2</sup> NOM approved models available. Add an "N" to suffix of model number when ordering (e.g., **H3D T832 C U 1 10N**).
- <sup>3</sup> Actual number may vary with lamp model. Please consult lamp manufacturer for lamp-specific data.

<b>Job Name:</b>	<b>Model Numbers:</b>
<b>Job Number:</b>	

### Hi-lume® 3D Ballasts for Linear and U-Bent T8 Lamps (continued)

For proper dimming, all lamps must comply with accepted standards: 17, 25, 32, 40 W (NEMA LL9-2009)

Not for use with reduced-wattage lamps.

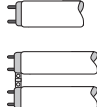
Lamp Type	Lamp Watts (length)	Lamps per Ballast	Case Size	Hi-lume® 3D Model Number	Input Voltage (V~)	Ballast Current (A)	Ballast Factor (BF)	Input Power (W)	System Lumens <sup>3</sup> (lm)	System Efficacy <sup>3</sup> (lm/W)	Ballast Efficacy Factor (BEF)	Relative System Efficacy (RSE)
	25 W (36 in [914 mm])	1	C	H3D T825 C U 1 10 <sup>2</sup>	120 240 277	0.26 0.11 0.11	1.00 1.00 1.00	31.2 26.4 30.5	1900 1900 1900	61 72 62	3.21 3.79 3.28	0.80 0.95 0.82
		1	C	H3D T825 C U 1 17	120 240 277	0.28 0.14 0.12	1.17 1.17 1.17	33.6 33.6 33.2	2223 2223 2223	66 66 67	3.48 3.48 3.52	0.87 0.87 0.88
		2	C	H3D T825 C U 2 10 <sup>2</sup>	120 240 277	0.47 0.23 0.20	1.00 1.00 1.00	56.4 55.2 55.4	3800 3800 3800	67 69 69	1.77 1.81 1.81	0.89 0.91 0.90
		2	C	H3D T825 C U 2 17	120 240 277	0.51 0.25 0.22	1.17 1.17 1.17	61.2 60.0 60.9	4446 4446 4446	73 74 73	1.91 1.95 1.92	0.96 0.98 0.96
	17 W (24 in [610 mm])	1	C	H3D T817 C U 1 10 <sup>1,2</sup>	120 240 277	0.18 0.09 0.08	1.00 1.00 1.00	21.6 21.6 22.2	1300 1300 1300	60 60 59	4.63 4.63 4.51	0.79 0.79 0.77
			G	H3D T817 G U 1 10 <sup>1,2</sup>	120 240 277	0.19 0.09 0.08	1.00 1.00 1.00	22.9 22.6 22.8	1300 1300 1300	57 58 57	4.37 4.42 4.39	0.74 0.75 0.75
			C	H3D T817 C U 1 17 <sup>1</sup>	120 240 277	0.19 0.10 0.08	1.17 1.17 1.17	22.8 24.0 22.2	1521 1521 1521	67 63 69	5.13 4.88 5.28	0.87 0.83 0.90
		1	G	H3D T817 G U 1 17 <sup>1</sup>	120 240 277	0.20 0.10 0.09	1.17 1.17 1.17	25.3 25.3 25.6	1521 1521 1521	60 60 59	4.62 4.62 4.57	0.79 0.79 0.78
			2	C	H3D T817 C U 2 10 <sup>1,2</sup>	120 240 277	0.31 0.15 0.13	1.00 1.00 1.00	42.0 43.2 41.6	2600 2600 2600	62 60 63	2.38 2.31 2.41
		2	G	H3D T817 G U 2 10 <sup>1,2</sup>	120 240 277	0.32 0.16 0.14	1.00 1.00 1.00	38.7 38.4 39.1	2600 2600 2600	67 68 66	2.58 2.60 2.56	0.88 0.89 0.87
			C	H3D T817 C U 2 17 <sup>1</sup>	120 240 277	0.36 0.17 0.15	1.17 1.17 1.17	42.0 40.8 41.6	3042 3042 3042	72 75 73	2.79 2.87 2.82	0.95 0.98 0.96
		2	G	H3D T817 G U 2 17 <sup>1</sup>	120 240 277	0.36 0.18 0.15	1.17 1.17 1.17	41.8 41.7 43.1	3042 3042 3042	73 73 71	2.80 2.81 2.71	0.95 0.95 0.92
			3	G	H3D T817 G U 3 10 <sup>1</sup>	120 240 277	0.48 0.25 0.21	1.00 1.00 1.00	57.6 60.0 58.2	3900 3900 3900	68 65 67	1.74 1.67 1.72
		3	G	H3D T817 G U 3 17 <sup>1</sup>	120 240 277	0.55 0.27 0.23	1.17 1.17 1.17	66.0 64.8 63.7	4563 4563 4563	69 70 72	1.77 1.81 1.84	0.90 0.92 0.94

**Notes**

- <sup>1</sup> BAA models available. Add a "U" to prefix of model number when ordering (e.g., **UH3D** T832 C U 1 10).
- <sup>2</sup> NOM approved models available. Add an "N" to suffix of model number when ordering (e.g., H3D T832 C U 1 10**N**).
- <sup>3</sup> Actual number may vary with lamp model. Please consult lamp manufacturer for lamp-specific data.

<b>Job Name:</b>	<b>Model Numbers:</b>
<b>Job Number:</b>	

## Hi-lume® 3D Ballasts for Linear T5 Lamps

For proper dimming, all lamps must comply with accepted standards: 14 W (60081-IEC-6520), 21 W (60081-IEC-6530), 28 W (60081-IEC-6640).

Not for use with reduced-wattage lamps.

Lamp Type	Lamp Watts (length)	Lamps per Ballast	Case Size	Hi-lume® 3D Model Number	Input Voltage (V~)	Ballast Current (A)	Ballast Factor (BF)	Input Power (W)	System Lumens <sup>3</sup> (lm)	System Efficacy <sup>3</sup> (lm/W)	Ballast Efficacy Factor (BEF)	Relative System Efficacy (RSE)
T5 Linear 	28 W (45.2 in [1148 mm])	1	C	H3D T528 C U 1 10 <sup>1,2</sup>	120	0.28	1.00	33.6	2900	86	2.98	0.83
					240	0.13	1.00	31.2	2900	93	3.21	0.90
					277	0.12	1.00	33.0	2900	88	3.63	0.85
		2	C	H3D T528 C U 2 10 <sup>1,2</sup>	120	0.52	1.00	62.4	5800	93	1.60	0.90
					240	0.26	1.00	62.4	5800	93	1.60	0.90
					277	0.22	1.00	59.8	5800	97	1.67	0.94
	21 W (33.4 in [848 mm])	1	C	H3D T521 C U 1 10 <sup>1,2</sup>	120	0.22	1.00	26.3	2100	80	3.81	0.80
					240	0.11	1.00	26.3	2100	80	3.81	0.80
					277	0.10	1.00	26.6	2100	79	3.76	0.79
		2	C	H3D T521 C U2 10 <sup>1,2</sup>	120	0.41	1.00	48.7	4200	86	2.05	0.86
					240	0.20	1.00	48.6	4200	86	2.06	0.86
					277	0.18	1.00	48.5	4200	87	2.06	0.87
14 W (21.6 in [549 mm])	1	C	H3D T514 C U 1 10 <sup>1,2</sup>	120	0.16	1.00	19.2	1350	70	5.21	0.73	
				240	0.08	1.00	19.2	1350	70	5.21	0.73	
				277	0.07	1.00	19.4	1350	70	5.16	0.72	
	2	C	H3D T514 C U 2 10 <sup>1,2</sup>	120	0.30	1.00	36.0	2700	75	2.78	0.78	
				240	0.15	1.00	36.0	2700	75	2.78	0.78	
				277	0.13	1.00	36.0	2700	75	2.78	0.78	

### Notes

- <sup>1</sup> BAA models available. Add a "U" to prefix of model number when ordering (e.g., **UH3D** T832 C U 1 10).
- <sup>2</sup> NOM approved models available. Add an "N" to suffix of model number when ordering (e.g., H3D T832 C U 1 10**N**).
- <sup>3</sup> Actual number may vary with lamp model. Please consult lamp manufacturer for lamp-specific data.

Job Name:	Model Numbers:
Job Number:	

## Hi-lume® 3D Ballasts for Linear T5HO Lamps

For proper dimming, all lamps must comply with accepted standards: 24W (60081-IEC-6620), 39 W (60081-IEC-6730), 54 W (60081-IEC-6840).

Not for use with reduced-wattage lamps.

Lamp Type	Lamp Watts (length)	Lamps per Ballast	Case Size	Hi-lume® 3D Model Number	Input Voltage (V~)	Ballast Current (A)	Ballast Factor (BF)	Input Power (W)	System Lumens <sup>3</sup> (lm)	System Efficacy <sup>3</sup> (lm/W)	Ballast Efficacy Factor (BEF)	Relative System Efficacy (RSE)
T5HO 	54 W (45.2 in [1148 mm])	1	C	H3D T554 C U 1 10 <sup>1,2</sup>	120 240 277	0.54 0.26 0.23	1.00 1.00 1.00	64.8 62.4 63.7	5000 5000 5000	77 80 78	1.54 1.60 1.57	0.83 0.87 0.85
		2	C	H3D T554 C U 2 10 <sup>1,2</sup>	120 240 277	0.95 0.48 0.42	1.00 1.00 1.00	114.0 115.2 116.3	10,000 10,000 10,000	88 87 86	0.88 0.87 0.86	0.95 0.94 0.93
	39 W (33.4 in [848 mm])	1	C	H3D T539 C U 1 10 <sup>1,2</sup>	120 240 277	0.37 0.19 0.17	1.00 1.00 1.00	44.4 44.9 46.0	3500 3500 3500	79 78 76	2.25 2.23 2.17	0.88 0.87 0.85
		2	C	H3D T539 C U 2 10 <sup>1,2</sup>	120 240 277	0.70 0.35 0.29	1.00 1.00 1.00	84.0 84.0 81.4	7000 7000 7000	83 83 86	1.19 1.19 1.23	0.93 0.93 0.96
	24 W (21.6 in [549 mm])	1	C	H3D T524 C U 1 10 <sup>1,2</sup>	120 240 277	0.25 0.12 0.10	1.00 1.00 1.00	30.0 28.8 27.7	2000 2000 2000	67 69 72	3.33 3.47 3.61	0.80 0.83 0.87
		2	C	H3D T524 C U 2 10 <sup>1,2</sup>	120 240 277	0.46 0.23 0.20	1.00 1.00 1.00	54.6 55.2 55.4	4000 4000 4000	73 72 72	1.83 1.81 1.81	0.88 0.87 0.87

### Notes

- <sup>1</sup> BAA models available. Add a "U" to prefix of model number when ordering (e.g., **UH3D** T832 C U 1 10).
- <sup>2</sup> NOM approved models available. Add an "N" to suffix of model number when ordering (e.g., H3D T832 C U 1 10**N**).
- <sup>3</sup> Actual number may vary with lamp model. Please consult lamp manufacturer for lamp-specific data.

Job Name:	Model Numbers:
Job Number:	

## Hi-lume® 3D Ballasts for Twin-Tube T5 Lamps

Not for use with reduced-wattage lamps.

Lamp Type	Lamp Watts (length)	Lamps per Ballast	Case Size	Hi-lume® 3D Model Number	Input Voltage (V~)	Ballast Current (A)	Ballast Factor (BF)	Input Power (W)	System Lumens <sup>2</sup> (lm)	System Efficacy <sup>2</sup> (lm/W)	Ballast Efficacy Factor (BEF)	Relative System Efficacy (RSE)
T5 Twin-Tube 	50 W (22.5 in [572 mm])	1	G	H3D T550 G U 1 10 <sup>1</sup>	120 240 277	0.45 0.23 0.20	1.00 1.00 1.00	53.5 54.6 54.8	4000 4000 4000	75 73 73	1.87 1.83 1.82	0.93 0.92 0.91
		2	G	H3D T550 G U 2 10 <sup>1</sup>	120 240 277	0.84 0.42 0.36	1.00 1.00 1.00	99.8 99.8 98.7	8000 8000 8000	80 80 81	1.00 1.00 1.01	1.00 1.00 1.01
	40 W (22.5 in [572 mm])	1	G	H3D T540 G U 1 10 <sup>1</sup>	120 240 277	0.36 0.18 0.16	1.00 1.00 1.00	42.8 42.8 43.9	3100 3100 3100	72 72 71	2.34 2.34 2.28	0.93 0.93 0.91
		2	G	H3D T540 G U 2 10 <sup>1</sup>	120 240 277	0.64 0.32 0.27	1.00 1.00 1.00	76.0 76.0 74.0	6200 6200 6200	82 82 84	1.32 1.32 1.35	1.05 1.05 1.08
		3	G	H3D T540 G U 3 10 <sup>1</sup>	120 240 277	0.95 0.47 0.40	1.00 1.00 1.00	112.9 111.7 109.7	9300 9300 9300	82 83 85	0.89 0.90 0.91	1.06 1.07 1.09
	36 W (15.5 in [394 mm])	1	G	H3D T536 G U 1 10 <sup>1</sup>	120 240 277	0.33 0.17 0.14	1.00 1.00 1.00	39.2 40.4 38.4	2850 2850 2850	73 71 74	2.55 2.48 2.60	1.02 0.99 1.04
		2	G	H3D T536 G U 2 10 <sup>1</sup>	120 240 277	0.61 0.31 0.26	1.00 1.00 1.00	72.5 73.7 71.3	5700 5700 5700	89 77 70	1.38 1.36 1.40	1.10 1.09 1.12

### Notes

- <sup>1</sup> NOM approved models available. Add an "N" to suffix of model number when ordering (e.g., H3D T832 C U 1 10**N**).
- <sup>2</sup> Actual number may vary with lamp model. Please consult lamp manufacturer for lamp-specific data.

Job Name:	Model Numbers:
Job Number:	

### Case Dimensions

C

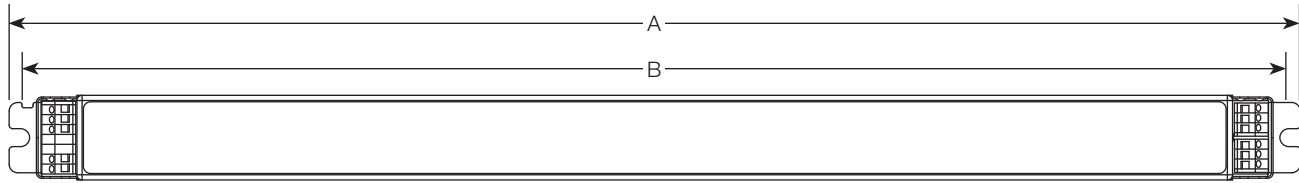

- A 18.0 in (457 mm)
- B 17.68 in (449 mm) (mounting center)
- C 1.0 in (25 mm)
- D 1.18 in (30 mm)

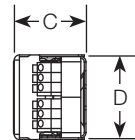

G

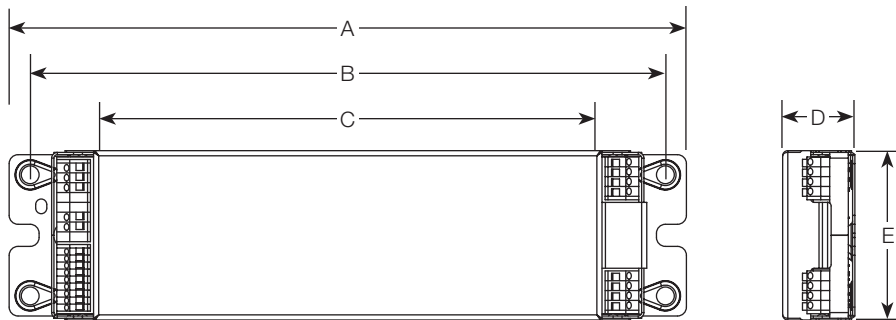

- A 9.5 in (241 mm)
- B 8.9 in (226 mm) (mounting centers)
- C 7.1 in (180 mm)
- D 1.0 in (25 mm)
- E 2.38 in (60 mm)

Job Name:  Job Number:	Model Numbers:
------------------------------	----------------



# Hi-lume® 3D Dimmer Wiring

## 3-Wire Control Wiring



**WARNING: Shock hazard. May result in serious injury or death.** Disconnect power before servicing or installing.

- Make sure that the supply breaker to the Digital Ballast is OFF when wiring
- Wire as shown

Line input	Connects to
Hot	Dimmer Black Wire
Neutral	Dimmer White Wire

Dimmer wire	Connects to
Yellow	Ballast Orange (DH)
Red	Ballast Black (HOT)
White	Ballast White (NEU)
Green	Earth Ground

- Hi-lume® 3D ballast line voltage and 3-wire input terminals accept one 18 to 16 AWG (0.75 to 1.5 mm<sup>2</sup>) solid copper wire per terminal.

### Emergency

- For emergency wiring please see Lutron® App Note #106.

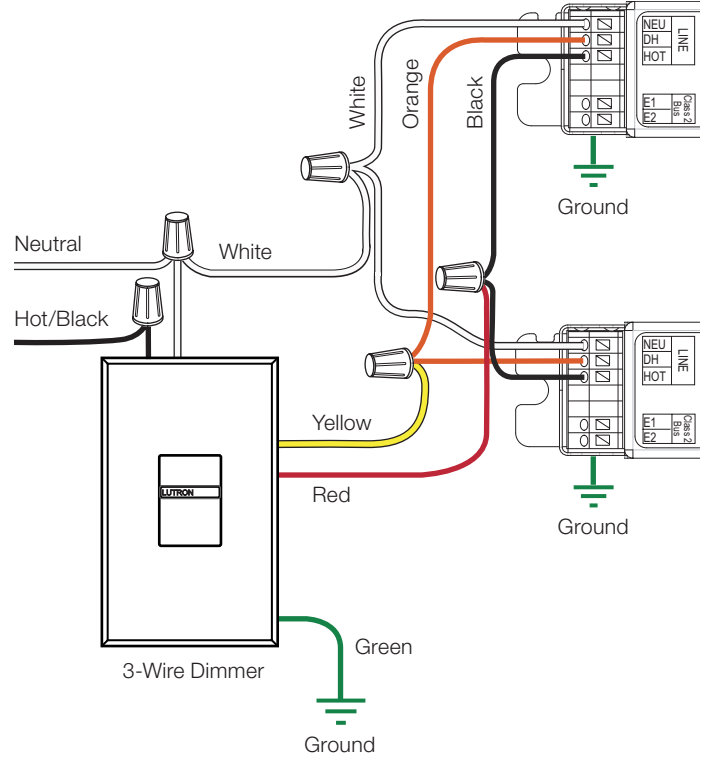

Job Name:	Model Numbers:
Job Number:	

## Hi-lume® 3D Wiring Diagrams

### EcoSystem® Digital Link Overview

- The EcoSystem® Digital Link wiring (E1 and E2) connects digital ballasts and drivers together to form a lighting control system.
- Sensors do not directly connect to Hi-lume® 3D ballasts.
- E1 and E2 (EcoSystem® digital link wires) are polarity-insensitive and can be wired in any topology.
- An Energi Savr Node™ with EcoSystem® unit, GRAFIK Eye® QS control unit with EcoSystem®, or Quantum® dimming module with EcoSystem® provides power for the EcoSystem® digital link which supports up to 64 digital ballasts or LED drivers, 64 occupant sensors, 16 daylight sensors, and 64 wall stations or IR receivers.
- PowPak® dimming module with EcoSystem® provides power for the EcoSystem® digital link which supports up to 32 digital ballasts or LED drivers, 6 occupant sensors, 1 daylight sensor, and 9 Pico® wireless controllers.
- All EcoSystem® Digital Link programming is completed by using the Energi Savr App for an *Apple iPad*, *iPod Touch*, or *iPhone* mobile digital device; GRAFIK Eye® QS with EcoSystem®; PowPak® dimming module with EcoSystem® or Quantum® System.
- For complete information, see EcoSystem® Design and Application Guide (P/N 3671533).
- For emergency wiring, please see Lutron® App Note #106.

### EcoSystem® Digital Link Wiring

- Ballast EcoSystem® Digital Link terminals accept one 18 to 16 AWG (0.75 to 1.5 mm<sup>2</sup>) solid copper wire per terminal.
- Make sure that the supply breaker to the Digital Ballast and EcoSystem® Digital Link Supply is OFF when wiring.
- Connect the two conductors to the two Digital Ballast terminals E1 and E2 as shown.
- Using two different colors for E1 and E2 will reduce confusion when wiring several ballasts together.
- The EcoSystem® Digital Link may be wired Class 1 or IEC PELV/NEC® Class 2. Consult applicable electrical codes for proper wiring practices.

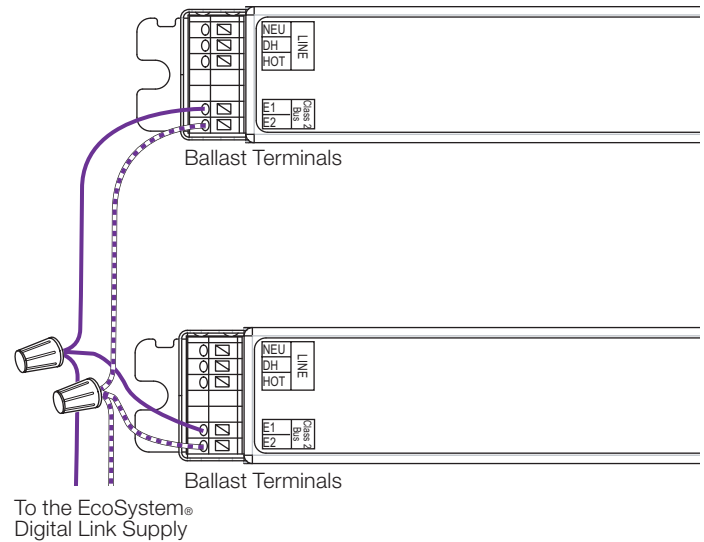

### Notes

- The EcoSystem® Digital Link Supply does not have to be located at the end of the Digital Link.
- EcoSystem® Digital Link length is limited by the wire gauge used for E1 and E2 as follows:

Wire Gauge	Maximum Digital Link Length
12 AWG	2200 ft
14 AWG	1400 ft
16 AWG	900 ft
18 AWG	550 ft

Wire Size	Maximum Digital Link Length
4.0 mm <sup>2</sup>	825 m
2.5 mm <sup>2</sup>	515 m
1.5 mm <sup>2</sup>	310 m
1.0 mm <sup>2</sup>	205 m
0.75 mm <sup>2</sup>	155 m

Apple, iPad, iPod Touch, and iPhone are trademarks of Apple Inc., registered in the U.S. and other countries.

<b>Job Name:</b>	<b>Model Numbers:</b>
<b>Job Number:</b>	

# Hi-lume® 3D Ballast Wiring Diagrams: T8, T5, and T5HO Linear Lamps

## Wiring to One Lamp (C case shown)

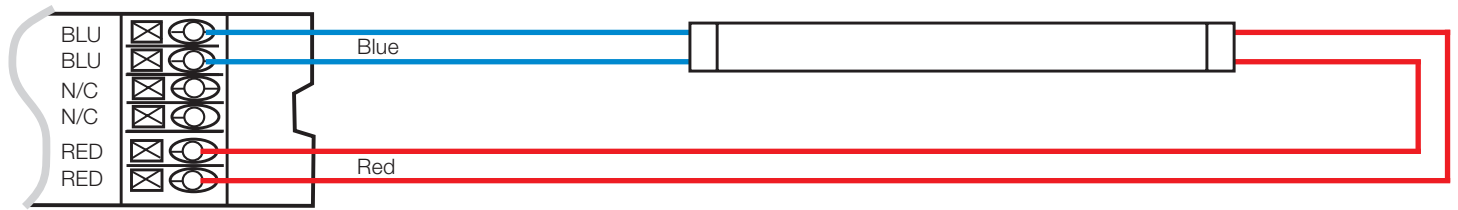

## Wiring to Two Lamps (C case shown)

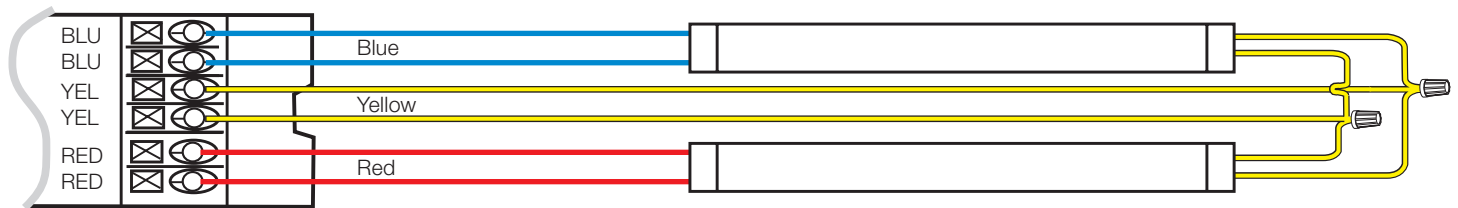

### NOTICE

- Maximum ballast to lamp socket lead length is 7 ft (2 m).
- Wire colors shown are labeled on the ballast, but may vary depending upon fixture construction.

Job Name:	Model Numbers:
Job Number:	

## Hi-lume® 3D Ballast Wiring Diagrams: T8, T5, and T5HO Linear Lamps

### Wiring to One Lamp (G case shown)

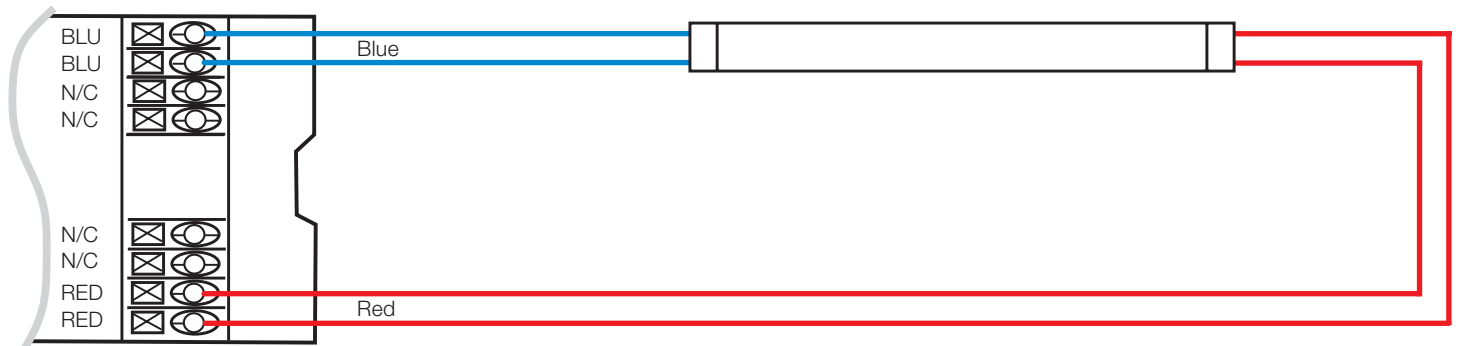

### Wiring to Two Lamps (G case shown)

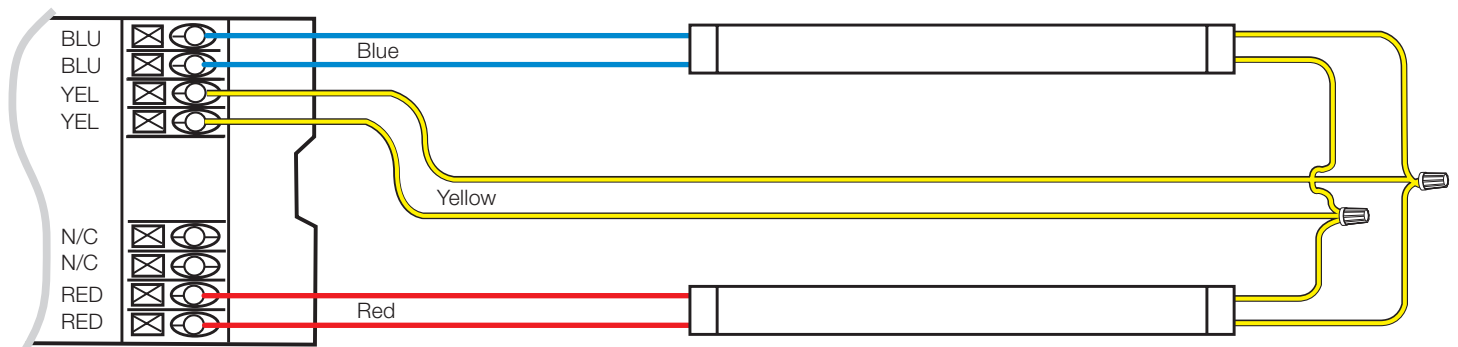

### Wiring to Three Lamps (G case shown)

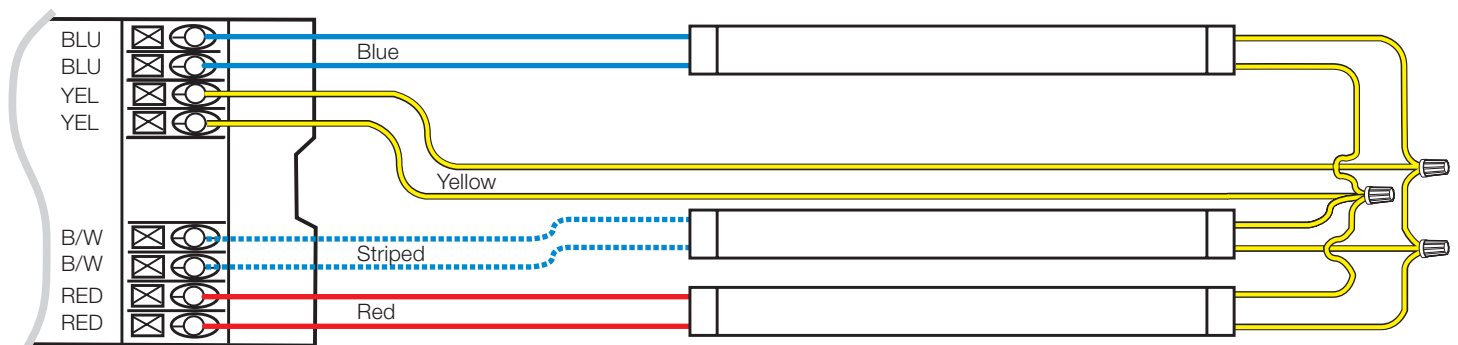

#### NOTICE

- Maximum ballast to lamp socket lead length is 7 ft (2 m).
- Wire colors shown are labeled on the ballast, but may vary depending upon fixture construction.

Job Name:	Model Numbers:
Job Number:	

# Hi-lume® 3D Ballast Wiring Diagrams: T5 Twin-Tube

## Wiring to One Lamp (C case shown)

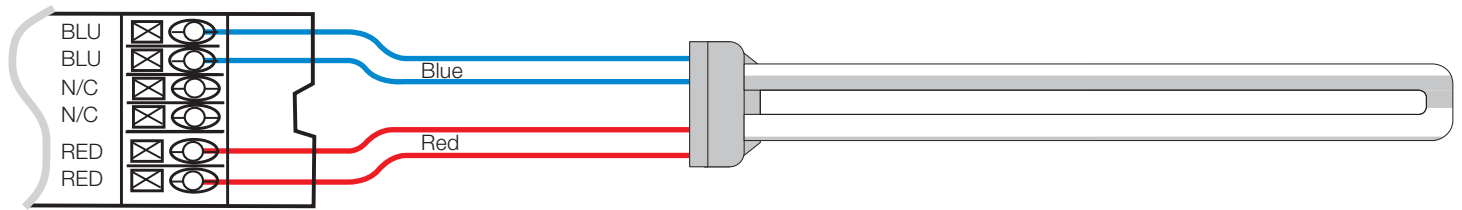

## Wiring to Two Lamps (C case shown)

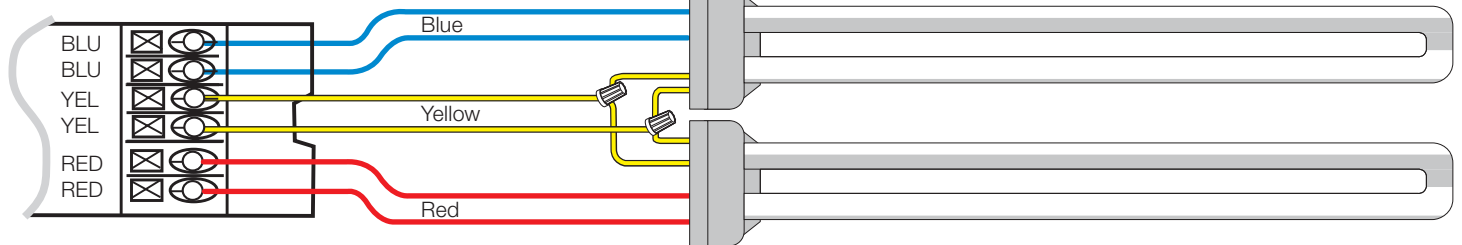

## Wiring to Three Lamps (G case shown)

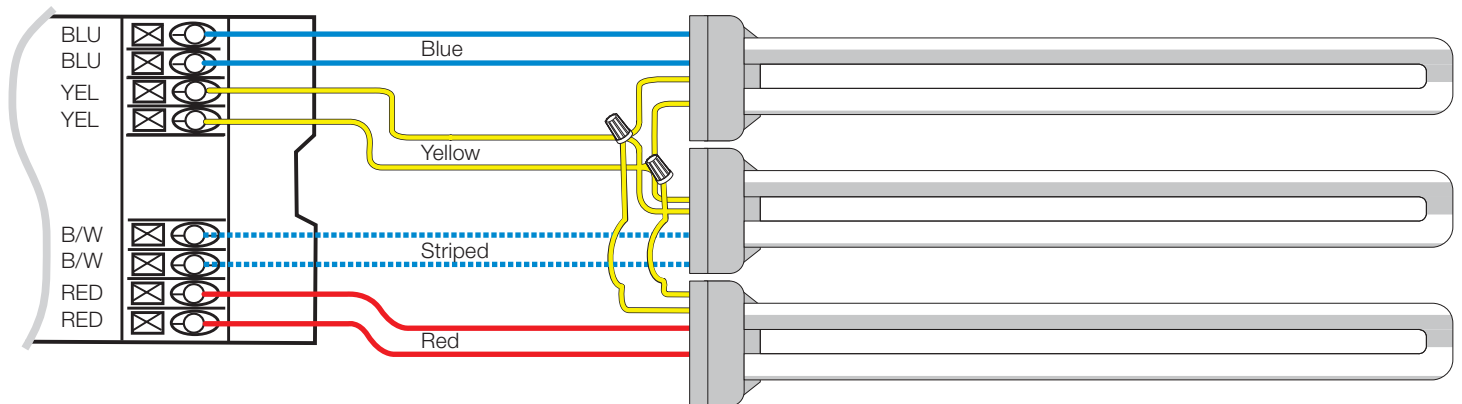

### NOTICE

- Maximum ballast to lamp socket lead length is 3 ft (1 m).
- Wire colors shown are labeled on the ballast, but may vary depending upon fixture construction.



Job Name:	Model Numbers:
Job Number:	

## Attention Electricians and Contractors

### Ballast/Socket Leads

Lead lengths from ballast to socket must not exceed 7 ft (2 m) for T8, T5, and T5HO linear lamps.

### Lamp Sockets

Lutron requires and NEMA® recommends sockets complying with IEC 60400. Inspect sockets for marks to ensure the socket complies with IEC 60400. Two examples of these marks are:  and . Sockets **must** have a  mark as well. Use Rapid Start sockets. DO NOT use Instant Start sockets. See Lutron® App Note #122 or NEMA® doc LSD-34-2006.

### Lamp Socket Wiring Tester

Use Socket Tester (FDB-LSWT-T5/T8) to verify proper lamp holder wiring.

Available for purchase at [www.lutronstore.com](http://www.lutronstore.com)

### Lamp Mounting

Many fluorescent lamp sockets are available with mounting slots to vary the height of the lamp away from the grounded metal surface. Having a fluorescent lamp too close to the grounded metal will reduce lamp life. Having a fluorescent lamp too far away from the grounded metal will make the lamp flicker or not turn on at all. Please note that all of the lamp heights are measured between the grounded metal surface and the glass wall of the lamp.

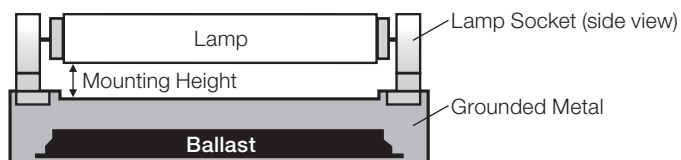

**IMPORTANT:** Lamps must never touch ground plane and should be placed without obstruction.

### Mounting for T8 Lamps

Mount lamps 1/8 to 3/4 in (3.2 to 19 mm) away from the grounded metal surface.

### Mounting for T5 and T5HO Lamps

Mount lamps 1/16 to 3/8 in (1.6 to 9.5 mm) away from the grounded metal surface.

### Mounting for T5 Twin Tube Lamps

Mount lamps 1/16 to 1/2 in (1.6 to 13 mm) away from the grounded metal surface.

### Ballast Operating Temperature

Ballast case temperature must not exceed 75 °C at any point on the ballast.

### Cold Air Flow

Ensure that no cold air (from HVAC system, etc) is blowing across the lamps. Cooling the lamp will cause performance issues as noted in NEMA LSD-34.

### Wiring and Grounding

Ballast and lighting fixture must be effectively grounded. Ballasts must be installed per national and local electrical codes.

## Attention Facilities Managers

### Performance

#### Lamp Seasoning

Consult lamp manufacturer’s recommendations on lamp seasoning prior to dimming.

### Service

#### Replacement Parts

Use Lutron® replacement parts with exact model numbers. Consult Lutron if you have any questions.

### Further Information

For further information, please visit us at: [www.lutron.com/ballasts](http://www.lutron.com/ballasts) or contact our 24-hour Technical Support Center at: 1.800.523.9466.

Job Name:	Model Numbers:
Job Number:	