

The designer dimmer that matches your paddle switches.



PRODUCT FAMILY FEATURES

- Large paddle switch with a captive linear-slide dimmer for a standard designer wallplate opening
- Full family of products for most lighting sources
- Dimmers feature built-in soft-glow nightlight
- Uses standard single-pole and 3-way wiring for easy installation in any home
- For more Diva choices, see the new Diva Satin Colors product line

DIMENSIONS



CONTROLS AND ACCESSORIES

Preset Dimmers



Fan-Speed Controls



Switches



Receptacles



15A Receptacle



15A GFCI Receptacle

Telephone/Cable TV Jacks



Single Telephone Jack



Cable TV Jack

Ports



6-Port Frame

Standard Multigang Wallplates



2-gang to 6-gang wallplates

SPECIFICATION SERIES STANDARD FEATURES



- Square Law Dimming
 - Power-failure memory
 - Electrostatic discharge tested
 - Mechanical air-gap switch to disconnect load power
 - RFI suppression
 - Captive linear slider
 - Precise color matching
- Lutron controls are rated at 120VAC, 60Hz unless otherwise noted.

JOB NAME	AREA CONTROLLED
LOCATION	JOB NUMBER
TITLE	PAGE NO.

Description	Maximum Capacity ¹	Model #
-------------	-------------------------------	---------

DIMMERS



Incandescent



Preset Dimmers with Nightlight

Single pole	600W	DV-600P-
Single pole	1000W	DV-10P-
3-way	600W	DV-603P-
3-way	1000W	DV-103P-

Note: The nightlight is visible best on the lighter colors. For 3-way and 4-way switching, use with Claro® switches or other mechanical switches.



Electronic Low Voltage



Preset Dimmers with Nightlight

Single pole	300W	DVELV-300P-
3-way	300W	DVELV-303P-

Note: Requires neutral wire connection. The nightlight is visible best on the lighter colors. For 3-way and 4-way switching, use with Claro switches or other mechanical switches.



Magnetic Low Voltage



Preset Dimmers with Nightlight

Single pole	600VA (450W ²)	DVLV-600P-
Single pole	1000VA (800W ²)	DVLV-10P-
3-way	600VA (450W ²)	DVLV-603P-
3-way	1000VA (800W ²)	DVLV-103P-

Note: The nightlight is visible best on the lighter colors. For 3-way and 4-way switching, use with Claro switches or other mechanical switches.



Fluorescent Dimming with Hi-lume® and Eco-10™ (ECO-Series) Electronic Ballasts



Preset Dimmers with Nightlight ³

Single pole/ 3-way	8A	DVF-103P-
Single pole/ 3-way, 277V	6A	DVF-103P-277-

Note: Use with Lutron Hi-lume or Eco-10 (ECO-Series) line voltage control Electronic Dimming Ballasts only. Requires neutral wire connection. The nightlight is visible best on the lighter colors. For 3-way and 4-way switching, use with Claro switches or other mechanical switches.



Fluorescent Dimming with Tu-Wire® Electronic Ballasts



Preset Dimmers with Nightlight

Single pole/ 3-way	5A	DVFTU-5A3P-
--------------------	----	-------------

Note: Use with Lutron Tu-Wire line voltage control electronic dimming ballasts only. The nightlight is visible best on the lighter colors. For 3-way and 4-way switching, use with Claro switches or other mechanical switches.

¹ For capacities in multigang installations see derating pg. 3.

² Actual lamp wattages.

³ No derating required if ganged.

⁴ A physical barrier (partition) must exist when ganging with line-voltage products.

Description	Maximum Capacity ¹	Model #
-------------	-------------------------------	---------

HI-POWER 2•4•6™ DIMMING MODULES

To increase load capacity up to 30,000W/VA in most popular sources, use one DV-600P- or DV-603P- and add up to five dimming modules. Cannot be used with 0-10VDC ballast.

FAN-SPEED CONTROLS



Quiet Controls



For use with one ceiling paddle fan.

Preset Fan-Speed Controls ³

Single pole/ 3-way, 3-speed	1.5A	DVFSQ-F-
-----------------------------	------	----------

Note: Does not have soft-glow nightlight. For 3-way and 4-way switching, use with Claro switches or other mechanical switches.

SWITCHES ³

General Purpose Switching of all Sources and Motor Loads



Single pole, 120/277V	15A	CA-1PSH-
3-way, 120/277V	15A	CA-3PSH-
4-way, 120/277V	15A	CA-4PSH-

ACCESSORIES

Receptacles



Receptacle ³

15A, 125V CAR-15H-



GFCI Receptacle ³

15A, 125V CAR-15-GFCIH-

Telephone and Cable Television Jacks

A physical barrier (partition) must exist when ganging with line-voltage products

Single Telephone Jack ⁴



6-conductor, RJ11	CA-PJH-
-------------------	---------

Note: Also accepts most 4-conductor plugs.



Cable TV Jack ^{3,4}

F-STYLE	
75-Ohm, coaxial cable jack	CA-CJH-

Description	Rating	Model #
-------------	--------	---------

ACCESSORIES

Field Customizable Multi-Port Frame









6-Port Frame	Shipped with 6 blanks <i>Shown with blanks</i>	CA-6PF- <input type="checkbox"/>
--------------	---	----------------------------------

Product above: For use with Lutron connectors shown below. Also compatible with Hubble Xcelerator™ and snap-fit connectors.

Connectors



For use with 6-port frame (CA-6PF-). Each connector fills one port.

	Phone Jack	6-conductor, RJ11, Category 3	CON-1P-C3-WH
	Phone Jack	8-conductor, RJ45, Category 5e	CON-1P-C5E-WH
	Phone Jack	8-conductor, RJ45, Category 6	CON-1P-C6-WH
	Fiber Jack	MT-RJ Feed-Through	CON-1F-MTRJ-WH
	Fiber Jack	SC Simplex	CON-1F-SC-WH
	Fiber Jack	LC Non-Flush Mount	CON-1F-LC-WH
	Fiber Jack	ST Style	CON-1F-ST-WH
	Cable Jack	F-Style, 75-Ohm Coaxial cable	CON-1C-WH
	BNC Jack	BNC connector	CON-1B-WH

Connectors available in white (WH) only. For information about additional colors contact Lutron Customer Service.

Description	Model #
-------------	---------

STANDARD WALLPLATES

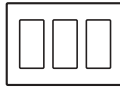
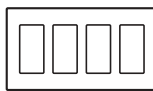
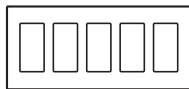
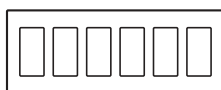
	1-Gang 2.94"W (75mm) x 4.69"H (119mm) x 0.30"D (7.6mm) CW-1-
	2-Gang 4.75"W (121mm) x 4.69"H (119mm) x 0.30"D (7.6mm) CW-2-
	3-Gang 6.56"W (167mm) x 4.69"H (119mm) x 0.30"D (7.6mm) CW-3-
	4-Gang 8.37"W (213mm) x 4.69"H (119mm) x 0.30"D (7.6mm) CW-4-
	5-Gang 10.18"W (259mm) x 4.69"H (119mm) x 0.30"D (7.6mm) CW-5-
	6-Gang 12.00"W (305mm) x 4.69"H (119mm) x 0.30"D (7.6mm) CW-6-

STANDARD COLORS/FINISHES



Gloss Finishes (Ships in 48 hours)

Add color/finish suffix to model number to order.

Example: DV-600P-**WH**

WH	White
IV	Ivory
AL	Almond
LA	Light Almond
GR	Gray
BR	Brown
BL	Black

DERATING/MAXIMUM CAPACITY

		
No side sections removed (Full Capacity)	One side section removed (End Units)	Two side sections removed (Middle Unit)

Incandescent Dimmers

600W 1000W	500W 800W	400W 650W
---------------	--------------	--------------

Electronic Low Voltage ¹

300W	250W	200W
------	------	------

Magnetic Low Voltage

600VA (450W ²)	500VA (375W ²)	400VA (300W ²)
1000VA (800W ²)	800VA (650W ²)	650VA (500W ²)

Fluorescent

Hi-lume/Eco-10 (ECO-Series)	20ballasts/8A	No derating required
Tu-Wire ³	5A	4A
		3.3A

Fan-Speed Controls

1.5A	No derating required
------	----------------------

¹ Requires 40W minimum load.
² Actual lamp wattage.
³ Minimum capacity: 2 ballasts/0.25A

WIRING DIAGRAMS

**Wiring Diagram 1
Single-Pole Wiring**

Model #

DV-600P-
DV-10P-
DVLV-600P-
DVLV-10P-
CA-1PSH-



Ground
 Wire Connectors
 * or Brass screw terminal
 ** or Green screw terminal

**Wiring Diagram 4
3-Way Wiring**

Model #

DVELV-303P-
CA-3PS-

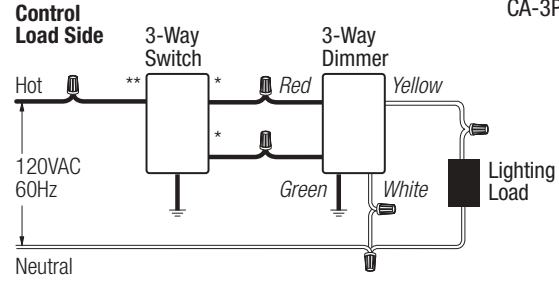

Ground
 Wire Connectors
 * or Copper/Black screw terminal
 ** or Brass/Gold screw terminal

**Wiring Diagram 2
Single-Pole Wiring of 3-Way Control**

Model #

DVFSQ-F-
DVLV-103P-
DVLV-603P-
DV-103P-
DV-603P-

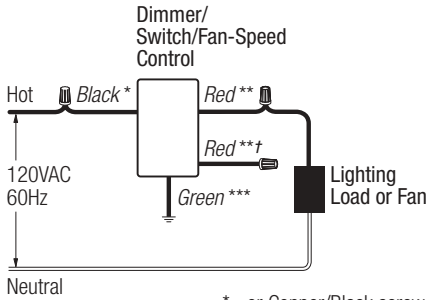

Ground
 Wire Connectors
 * or Copper/Black screw terminal
 ** or Brass screw terminal
 *** or Green screw terminal
 † or Red/White stripe (cap off)

**Wiring Diagram 5
3-Way Used as Single Pole**

Model #

DVELV-303P-

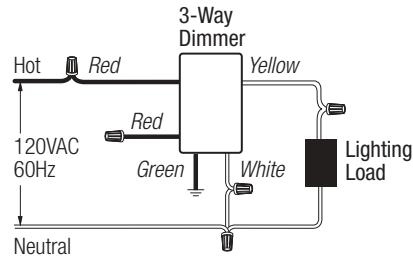

Ground
 Wire Connectors

**Wiring Diagram 3
Single-Pole Wiring**

Model #

DVELV-300P-



Ground
 Wire Connectors

WIRING DIAGRAMS

**Wiring Diagram 6
3-Way Wiring**



Model #

- DV-603P-
- DV-103P-
- DVLV-603P-
- DVLV-103P-
- DVFSQ-F-
- CA-3PSH-

**Wiring Diagram 7
4-Way Wiring**



Model #

- DV-603P-
- DV-103P-
- DVLV-603P-
- DVLV-103P-
- DVFSQ-F-
- CA-3PSH-
- CA-4-PSH-

WIRING DIAGRAMS

Wiring Diagram 12 Cable TV Jack Wiring

Model #



CA-CJH-

Wiring Diagram 13 Telephone Jack Wiring

Model #



CA-PJH-

*accepts most 4-conductor jacks

Wiring Diagram 14 Receptacle Wiring

Model #

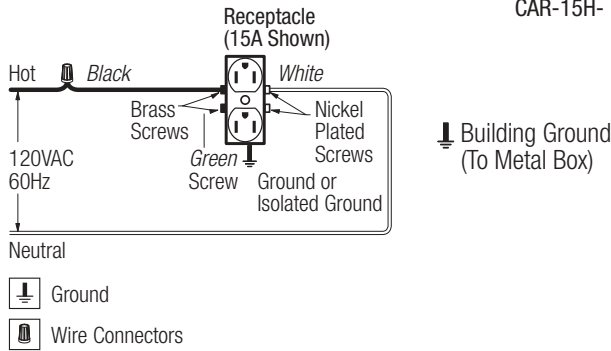

CAR-15H-

Wiring Diagram 15 GFCI Receptacle Wiring

Model #

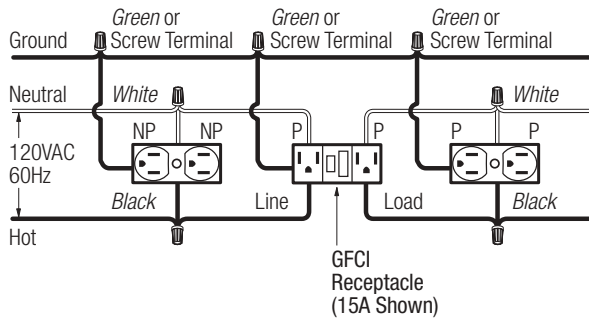

CAR-15-GFCIH-

P-Protected
NP-Not Protected

Wire Connectors

DIVA CONTROLS AND ACCESSORIES

PART 1 – GENERAL

1.01 SUMMARY

- A. Scope: Provide, install and test all switches, dimmers and related devices as specified herein for the areas indicated on the drawings, specifications, and load schedules.
- B. Related Sections: Section 16580 (Ballasts), Section 16570 (Dimming Systems).

1.02 REFERENCES

- A. UL 20, UL 1472, CSA, NOM, ISO 9001

1.03 SYSTEM DESCRIPTION AND OPERATION

- A. Permanently installed, wallbox mounted switches and dimmers
- B. Permanently installed, wallbox mounted fan-speed controls
- C. Permanently installed, wallbox mounted receptacles
- D. Permanently installed, wallbox mounted data, voice and cable jacks
- E. Screwless, seamless wallplates

1.04 SUBMITTALS

- A. Submit manufacturer's standard catalog data giving all application, wiring, and installation information on basic components and wallplate kits. Provide test data and/or samples as required to demonstrate conformance with PART 2 of this specification.

1.05 QUALITY ASSURANCE

- A. Manufacturer shall have a minimum of 10 years continuous experience in manufacturing wallbox dimming products.
- B. Dimmers, switches and Fan-speed controls shall be UL listed, CSA and NOM approved specifically for each required load (i.e., tungsten, electronic low voltage transformer, magnetic low voltage transformer, and fluorescent). Manufacturer shall provide file card or certificate upon request. Universal load-type dimmers shall not be acceptable.
- C. Manufacturer shall maintain ISO 9001 certification and provide a copy of the certificate upon request.

1.06 WARRANTY

- A. All devices shall be covered by a minimum one-year warranty.

PART 2 – EQUIPMENT

2.01 ACCEPTABLE MANUFACTURERS

- A. Lutron Electronics Co., Inc.
- B. Unless otherwise noted, all basic components (dimmer, fan-speed control, switch, receptacle, telephone jack and cable TV jack) and wallplate kits shall be provided by one manufacturer.

2.02 EQUIPMENT

- A. Controls Lutron Diva Style
 - 1. Performance
 - a. Dimmers shall provide full-range, continuously variable control of light intensity.
 - b. Wall controls shall fit a decorator wallplate opening with a paddle switch. Dimmers shall have a small, raised slider to the right of the paddle switch. Controls shall have a gloss finish.

- c. When on, the slider shall change the light level/fan speed. When off, the slider shall preselect the light level/fan speed that the control will turn on to. Paddle switch shall turn lights/fan on to the preselected level, or off.
 - d. Paddle switch and slider shall be captured internal to the control.
 - e. 3-Way controls shall be capable of multi-location on and mechanical air-gap off using standard 3-way and 4-way switches. Multi-location switches shall be Claro decorator style with a gloss finish.
 - f. Dimmer shall be backlit with soft glow locator light.
 - g. Within rated capacity, dimmers shall be available for direct control of incandescent, magnetic low voltage, electronic low voltage, and fluorescent. Matching fan-speed controls shall also be available.
 - h. Controls shall be capable of operating at the rated capacity; this includes modified capacities for ganging configurations which require the removal of fins. Operation at rated capacity shall be possible across the full ambient temperature range, without shortening design lifetime.
 - i. To ensure a precise color match between all plastic parts, color variation of any gloss finish control shall not exceed a delta E of 1, CIE L*a*b* color units, as defined in ASTM E 308-99.
 - j. Dimmer shall provide smooth and continuous Square Law dimming curve, for the full slider travel, on their rated load per The IESNA Lighting Handbook, 9th edition, p. 27-4.
 - k. Controls shall meet the applicable requirements of UL 20 and UL 1472 referring to the inclusion of a visible, accessible air-gap off switch and the limited short circuit test.
 - l. Controls shall meet ANSI/IEEE Std. C62.41-1980, tested to withstand voltage surges of up to 6000V and current surges of up to 200A without damage.
 - m. Dimmers shall be designed to reduce interference with radio, audio, and video equipment.
 - n. Controls shall incorporate power-failure memory. Should power be interrupted and subsequently returned, the lights or fans will come back on to the same levels set prior to the power interruption. Restoration to some other default level is not acceptable.
 - o. Controls shall not be susceptible to damage or loss of memory due to static discharge.
 - p. Controls shall operate in an ambient temperature range of 0°C (32°F) to 40°C (104°F).
 - q. 3-Way controls shall wire using conventional 3-way and 4-way wire runs.
 - r. Contractors shall install all backboxes with a minimum wallbox depth of 2.5 inches.
- 2. Incandescent Dimmers
 - a. Provide single-pole and 3-way incandescent dimmers in 600 Watts and 1000 Watts capacities.
 - b. Dimmer shall be capable of operating in either 3-way switch location.
 - c. Dimmer shall be capable of operating in either 3-way switch location.
 - 3. Electronic (Solid State) Low Voltage (ELV) Transformer Dimmers
 - a. Provide ELV dimmers for direct control of up to 300 watts of electronic low voltage load.
 - b. Dimmers shall contain circuitry specifically designed to control the input of electronic (solid state) low voltage transformers. Dimmers using standard phase control shall not be acceptable.

- c. Dimmers shall have a resettable overload protection that automatically shuts off when dimmer capacity is exceeded. Protection methods that are non-resettable or require the device to be removed from the wall to reset shall not be acceptable.
 - d. Dimmers shall be designed to withstand a short, per UL 1472 section 5.10, between load hot and either neutral or ground without damage to the dimmer.
4. Magnetic Low Voltage (MLV) Transformer Dimmers
- a. Provide MLV dimmers for direct control of up to 1000 volt amps of electronic low voltage load.
 - b. Dimmers shall contain circuitry specifically designed to control and provide a symmetrical AC waveform to the input of magnetic low voltage transformers per UL1472 section 5.11.
 - c. Dimmers shall not cause a magnetic low voltage transformer to operate above the transformers rated operating current or temperature.
 - d. Dimmer shall be capable of operating in either 3-way switch location.
5. Fluorescent Dimming Ballast Dimmers
- a. Provide Fluorescent dimmers for direct control of fluorescent dimming ballasts up to the manufacturers specified rating.
 - b. Dimmers shall be designed to operate the following ballasts. Dimmers and ballasts shall be produced by the same manufacturer to ensure proper ballast/control compatibility:
 - 1) Hi-lume® Architectural Dimming Ballasts (1% 3-wire)
 - 2) Hi-lume® Compact™ Lamp Dimming Ballasts (5% 3-wire)
 - 3) Eco-10™ Lighting Management Dimming Ballasts (10% 3-wire)
 - 4) Tu-Wire™ High Performance Dimming Ballasts (5% 2-wire)
6. Remote dimming modules for high power loads
- a. Where lighting loads exceed the full rated capacity of single dimmers, provide a Diva incandescent dimmer driving high power modules. High power module and dimmer shall be from the same manufacturer to ensure compatibility.
 - b. High power modules shall be remotely mounted.
 - c. High power module shall be rated and UL listed for control of incandescent, magnetic low voltage, electronic low voltage, fluorescent, and neon/cold cathode loads in increments of 2,000 Watts up to 30,000 Watts.
7. Fan-Speed Controls:
- a. Fan-speed controls shall be UL Listed, CSA and NOM approved, Lutron Diva style.
 - b. Quiet fan-speed model shall provide three speed settings with paddle providing preset on and off.
 - c. Quiet fan-speed control shall provide single-pole/3-way control of one paddle fan (1.5A max.).
- B. Accessories Lutron Claro Style
1. Switch Components Lutron Claro Style
 - a. Switches shall provide on/off control of any 120/277 VAC load up to 15A. Switches shall be UL Listed as general-use AC switches, Lutron Claro style.
 - b. Switches shall be available in single-pole, 3-way and 4-way configurations.
 2. Receptacle Components Lutron Claro Style
 - a. All receptacles shall be UL Listed, CSA and NOM approved.
 - b. Receptacles shall be two pole, three wire ground and rated for 15A at 125VAC. All receptacles shall be NEMA configuration type 5-15R.
 - c. Ground-fault interrupter receptacles shall be Lutron Claro style with two-pole, three-wire ground and rated 15A at 125VAC Configuration shall be of the duplex type with rectangular NEMA WD-6 design. Receptacles shall have a 5 milliampere ground-fault trip level with "test" and "reset" buttons.
3. Telephone Jack and Cable TV Jack Components Lutron Claro Style
- a. Contractor shall provide an appropriate barrier (partition) to isolate jack from high-voltage wiring when ganged with a dimmer, fan-speed control, switch, or receptacle. This complies with NEC Articles 800-3 and 820-13.
 - b. Telephone jack shall be designed to mate with standard 4- or 6-conductor modular jacks, and be compatible with 2, 4, or 6 conductor lines. Telephone jacks shall meet FCC Part 68, paragraph F standards to ensure compatibility with U.S. telephone systems.
 - c. Cable TV jacks shall be the coaxial type, designed for use with standard 75-Ohm cables.
- C. Wallplates Lutron Claro Style
1. Wallplates shall be manufactured from durable polycarbonate plastic with gloss finish, and shall attach to the basic components without using exposed hardware or screws.
 2. Multigang wallplates shall provide a continuous, seamless cover for up to six-ganged decorator-style control and accessory combinations with no exposed hardware or screws.
 3. Multigang wallplates shall include an adapter plate for proper device alignment and wallplate attachment.
 4. Control, accessory and wallplate profiles shall not exceed .30 inches from wall surface to faceplate front surface.
 5. To ensure a precise color match between all plastic parts, color variation of any gloss finish control or wallplate shall not exceed a delta E of 1, CIE L*a*b* color units, as defined in ASTM E 308-99.
 6. Visible parts of dimmers, switches, standard receptacles, cable jacks or any wallplate shall exhibit ultraviolet stability when tested with multiple actinic light sources as defined in ASTM D4674-89.
- 2.03 SOURCE QUALITY CONTROL**
- A. All dimming controls shall be 100% function tested at the time of manufacture. Statistical sampling plan shall not be acceptable.

PART 3 – EXECUTION

3.01 INSTALLATION

- A. Contractor shall furnish all devices (dimmers, accessories, & wallplate kits), labor and other services necessary for the proper installation of the devices as indicated on the drawings and specified herein.
- B. Contractor shall be responsible for derating dimmer capacity if side sections are removed.
- C. Contractor shall run separate neutral wires in 120/208 VAC installations.
- D. Devices shall be installed utilizing manufacturer's recommended application, wiring and installation instructions.
- E. Contractor to provide seamless wallplate covers per specification 2.02 for all devices ganged in a common box. Contractor shall provide barriers within the box where required by code.

3.02 FIELD QUALITY CONTROL

- A. Twenty-four hours a day, seven days a week, global customer service and technical hotline available.
- B. Supplemental information shall be provided by manufacturer's Internet site.